



Abzieher · Puller · Extracteur · Extractore
Trekker · Estrattori · Ściągacze · 拆卸工具



Dealer price list

Fachhandels-Preisliste · Tarif détaillants **W**



	Spannweite spread		Adapter Innenvierkant inner square drive (adapter)		Durchmesser des Sicherungs-Innenringes diameter of circlip (inner ring)
	Spanntiefe depth		Gewinde thread		Schlaghülsendurchmesser diameter of impact sleeves
	Höhe des Abzughakenfußes length of claw		Durchmesser des Gewindes thread diameter		Anzahl der Schlaghülsen number of impact sleeves
	Abzughakenlänge length of the jaw		Länge des Gewindes length of thread		Durchmesser des Schlagringes diameter of impact ring
	Höhe der Verlängerung length of extension		Gewindelänge der hydraulischen Spindel thread length of hydraulic spindle		Anzahl der Schlagringe number of impact rings
	Fußöffnung des Abzughakens opening of claw end		Spindelspitzendurchmesser diameter of cone end		Anzahl der Abstützringe number of rings
	Länge der Spindel spindle length		Spindelspitzenhöhe length of cone end		Bohrerdurchmesser diameter of drill
	Antrieb Außensechskant hexagon drive (male)		Spannweite der Zwinde spread of clamp		Durchmesser der Insert-Hülse diameter of insert sleeve
	Antrieb Außenvierkant square drive (male)		Muttergröße nut size		Länge der Insert Hülse length of insert sleeve
	Antrieb Innensechskant hexagon drive (female)		Schneidbereich cutting area		Steigung der Insert Hülse thread pitch of insert sleeve
	Antrieb Innenvierkant square drive (female)		Länge ohne Druckspindel length (without pressure spindle)		Anzahl der Hülsen number of sleeves
	Gabelöffnung fork opening		Anzahl der Spanntiefenverstellung number of positions		Kettenbolzendurchmesser diameter of chain pin
	Gabelöffnung konisch fork opening (conical)		Anzahl der Arme number of arms		Schlagweg length of impact area
	Hebelspannbereich opening range		Höhe des Zylinders height of cylinder		Schlagmasse mass
	Gabelöffnung fork opening		Hub cylinder stroke		Lenksäulendurchmesser diameter of steering column
	lichte Höhe clear height		Federspannbereich spread		Lochkreisdurchmesser diameter of pitch circle
	lichte Weite clear width		Federdurchmesser diameter		Spreizbereich spread area
	Fußstärke thickness (of material)		Anzahl der Federhalter number of segments		Gewindedurchmesser der Schraube thread diameter
	Durchmesser der Trennmesser diameter of separator		Breite des Grundgerätes width of basic unit		Stehbolzendurchmesser bolt diameter
	Abstand der Seitenbolzen distance of side screw		Höhe des Grundgerätes height of basic unit		Durchmesser des Spannfutters diameter of chuck
	Zugbolzenweite distance of side screw		Spannweite der Klemmbacken spread		Ventilfederspannweite spread of valve spring
	Zugbolzentiefe depth		Durchmesser der Flansche diameter of flanges		Bereich der Spannung voltage area
	Einsatztiefe effective depth		Kugellager ISO ball bearing ISO		Fördervolumen flow volume
	Länge der Innenauszieher length of internal		Innendurchmesser des Kugellagers inner diameter of ball bearings		nutzbares Ölvolumen effective volume
	Anzahl Segmente number of segments		Maximalgewicht des Kugellagers maximum weight of ball bearing		Inhalt content
	Gewinde des Adapters (Werkstückseite) thread of adapter		Durchmesser des Kolbenringes diameter of piston ring		Kompatibel mit compatible with
	Gewinde des Adapters (Zugbolzenseite) thread of adapter		Spanndurchmesser spread		Farbe color
	Anzahl der Adapter number of adapters		Spannhöhe height		Verpackungseinheit package unit
	Adapter Innensechskant inner hexagon drive (adapter)		Durchmesser des Sicherungs-Außenringes diameter of circlip (outer ring)		Gewicht weight

Sicherheits- und Gebrauchshinweise
Precautionary Notes and Helpful Hints

Werkzeuge dürfen grundsätzlich nur ihrem Zweck entsprechend, unter den vorgesehenen Bedingungen und innerhalb der Gebrauchsbeschränkungen benutzt werden.
 All tools must always be used for the intended purposes under the envisioned conditions and within their postulated limitations.

-  Überprüfen Sie regelmäßig den Zustand des Werkzeuges und ersetzen Sie beschädigte oder abgenutzte Teile.
 Check the condition of your tools at regular intervals, and replace any damaged or worn parts.
-  Halten Sie die Gewinde von Spindeln und Traversen stets rein und immer gut geölt.
 Keep the threads of all spindles, heads, etc. clean and well oiled.
-  Informieren Sie sich vor dem Einsatz über den richtigen Gebrauch des anzuwendenden Abziehwerkzeuges, unter Berücksichtigung der dabei erforderlichen Sicherheitsmaßnahmen. Before you start work, acquaint yourself with the proper use of the tool or tools in question, with due attention to pertinent safety measures.
-  Sofern über einen der genannten Punkte die geringste Unsicherheit besteht, sollte zur Klärung werkseitige Anwendungsberatung eingeholt werden.
 If anything at all is unclear about any of the above, it is best to call the factory for some firsthand advice.
-  Vergewissern Sie sich vor dem Einsatz, daß sich das Abziehwerkzeug in einwandfreiem Zustand befindet.
 Prior to starting work, make sure that the pulling tool is in good working order.
-  Überprüfen Sie die korrekte Anbringung des Werkzeuges und überwachen Sie während des Abziehvorganges die auftretenden Kräfte.
 Double-check the tool for correct mounting, and monitor the forces incidental to the pulling process.
-  Überschreiten Sie niemals, die für das Werkzeug vorgegebenen Belastungswerte. Kontrollieren Sie die Aufbringung der Abziehkraft bei mech. Abziehwerkzeugen durch Verwendung eines Drehmomentschlüssels und bei pumpenbetriebenen, hydr. Abziehwerkzeugen durch ein Manometer. Never violate the maximum load data prescribed for the tool in question. Use a torque wrench (for mechanical/pressure-screw-driven tools) or a pressure gauge (hydraulic/pump-driven tools) to keep tabs on the applied forces.
-  Tragen Sie stets eine Schutzbrille und geeignete Schutzkleidung.
 Always wear suitable personal protective equipment, including protective goggles.
-  Umhüllen Sie zum Schutz gegen das bei Abzieharbeiten immer mögliche ruckartige Ablösen Abziehwerkzeug und abzuziehendes Teil mit einer Unfallschutzplane. Always wrap the pulling tool and the workpiece in a protective blanket as a precaution against the potential effects of sudden release.
-  Bei Überlastungserscheinungen, Schwergängigkeit usw. ist der Abziehvorgang zu unterbrechen und eine größere Ausführung der entsprechenden Baureihe einzusetzen. If the tool appears to be overloaded, works sluggishly, or is otherwise negatively conspicuous, interrupt the pulling process, and replace the tool with a larger model.
-  Verwenden Sie keine elektrischen oder pneumatischen Kraft- oder Schlagschrauber zum Betätigen von Abziehwerkzeugen.
 Never use an electric- or pneumatic-powered impact/hammer drill for driving a pulling tool.
-  Verwenden Sie keine Verlängerungen zur Erhöhung des übertragenen Drehmomentes.
 Never use extensions to increase the applied torque.
-  Nehmen Sie keinerlei Veränderung an den Produkten vor.
 Never alter a pulling tool or related product in any way.
-  Da Stahl unter Wärmeeinfluß seine Festigkeitseigenschaften verändert, dürfen Abziehwerkzeuge bei evtl. Anwärmen abzuziehender Teile nicht miterwärmt werden.
 Since heat detracts from the thermal properties of steel, and since some parts require heating to facilitate their removal, remember to never heat the pulling tool along with the part.



Glide & FIX
TECHNOLOGY



Die optimierte Geometrie von Traverse und Gleitstücken sorgt für besonders leichtes Verschieben der Abzughaken auf der Traverse.
 The geometry of the cross-bar and sliding parts has been optimized to ensure particularly easy movement of the extractor jaws along the cross-bar.

ARMLOCK
TECHNOLOGY



Die Kreuzhaken garantieren maximale Stabilität der Aufhängung der Abzughaken im Gleitstück.
 The cross-jaws guarantee maximum stability for the mounted sliding parts and jaws.

Quick adjust
TECHNOLOGY



Ermöglicht durch die Handstellrändel ein schnelles Lösen und Verschieben, der Abzughaken auf der Traverse, ohne Schraubenschlüssel.
 A manual adjustment knurl allows rapid loosening and adjusting of the extractor jaws without using a wrench.

easyScrew
TECHNOLOGY



Leichtes Drehen der Betätigungsmutter durch eingebautes Drucklager. Der Reibungswiderstand wird auf ein Minimum reduziert.
 The operating nut is easy to turn thanks to a built-in pressure bearing. Resistance from friction is reduced to a minimum.

Light SHIFT
TECHNOLOGY



Leichtgängige, selbstverstellbare Abzughaken mit innenliegender Federung.
 Smooth-running, self-adjusting spring-back jaws.

hydraulic
TECHNOLOGY



Abziehwerkzeuge mit Hydraulikfunktion.
 Tools with hydraulic function.

Preis Gruppen
Price categories

Kategorie	☛	EURO	Kategorie	☛	EURO
PG 0	1	8,00	PG 7	1	165,00
PG 1	1	11,00	PG 8	1	220,00
PG 2	1	34,00	PG 9	1	290,00
PG 3	1	43,00	PG 10	1	425,00
PG 4	1	70,00	PG 11	1	575,00
PG 5	1	100,00	PG 12	1	900,00
PG 6	1	125,00			



Preisliste, Price list, Tarif, Prijislijst W-2014 (01.01.2014)
 Alle früheren Preislisten verlieren mit dieser Liste ihre Gültigkeit. Dieser Preisliste liegen unsere allgemeinen Geschäftsbedingungen zugrunde. Maße und Gewichte sind nur annähernd. Modell- und Ausführungsänderungen, Irrtümer und Druckfehler behalten wir uns vor. **Allgemeine Liefer- und Zahlungsbedingungen siehe www.kukko.com**
 Our general terms of business form the basis of this Price List. Measurements and weights are only approximate. All rights are reserved for alteration of models and finishes, mistakes and misprint. **General Terms and Conditions of Delivery and Payment see www.kukko.com**

Lange Hydraulikspindeln
ST

8-0



Long hydraulic spindles
 Vis hydrauliques longues
 Lange hydraulische spindels
 Husillos hidráulicos largos
 Viti idrauliche lunghe
 Długie wrzeciona hydrauliczne





Art.-No.		max. t	Bezeichnung description			EUR
8-01	-887871	10	Spindel komplett	12-4, 12-5, 18-2, 20-2, 20-20, 30-2, 30-20, 41-5, 42-5, 205-02, 206-02, 207-02	1	251,80
8-02	-887901	12	Spindel komplett	12-6, 12-7, 18-3, 20-3, 20-30, 30-3, 205-1, 205-2, 205-3, 206-1, 206-2, 206-3, 207-1, 207-3, 207-2	1	288,10
8-01ERS	-989452	-	Verschleiß-teilsatz	8-01	1	100,00
8-02ERS	-887918	-	Verschleiß-teilsatz	8-02	1	100,00

Lange Hydraulikspindeln
ST

8



Long hydraulic spindles
 Vis hydrauliques longues
 Lange hydraulische spindels
 Husillos hidráulicos largos
 Viti idrauliche lunghe
 Długie wrzeciona hydrauliczne

Art.-No.		 mm	 mm	max. t	Bezeichnung description			EUR
8-1-B	-034596	250	10	15	Spindel komplett	18-4, 20-4, 20-40	1	579,40
8-1-F	-034671	350	-	15	Spindel komplett	46-1-A, 46-1-B, 46-2-A, 46-2-B, 47-1-A, 47-1-B, 47-2-A, 47-2-B	1	597,80
8-1	-034428	-	10	15	Oberteil	8-1-B, 8-1-F	1	444,70
8-B	-034183	-	-	-	Unterteil	8-1-B	1	134,70
8-F	-034268	-	-	-	Unterteil	8-1-F	1	153,20
8-1-ERS	-243721	-	-	-	Verschleiß-teilsatz	8-1	1	148,40
8-2-K	-034831	250	10	20	Spindel komplett	11-1, 11-2	1	702,00
8-2-M	-034916	350	-	20	Spindel komplett	18-5, 20-5	1	809,90
8-2	-034756	-	10	20	Oberteil	8-2-K, 8-2-M	1	558,00
8-K	-035098	-	-	-	Unterteil	8-2-K	1	144,20
8-M	-035173	-	-	-	Unterteil	8-2-M	1	198,20
8-2-ERS	-243806	-	-	-	Verschleiß-teilsatz	8-2	1	162,30

Lange Hydraulikspindel mit Handhebelbetätigung

ST

8-HP



Long hydraulic spindles with handle
 Vis hydrauliques longues à commande par levier manuel
 Lange hydraulische spindel met pomp bediening
 Husillos hidráulicos largos con accionamiento de manecilla
 Viti idrauliche lunghe con comando a leva manuale
 Długie wrzeciona hydrauliczne uruchamianie za pomocą dźwigni ręcznej

Art.-No.		max. t	mm		mm			
8-HP-100	-101281	10	80	W1 1/2"-16	390		1	540,00

Hydraulische Zusatzpresse

ST

9



Auxiliary hydraulic ram
 Presse hydraulique auxiliaire
 Hydraulische hulppersen
 Prensa hidráulica auxiliar
 Pressa idraulica supplementare
 Hydrauliczna prasa dodatkowa

Art.-No.		∅ mm	mm	mm	max. t			EUR
9-1	-005053	37	60	10	10		1	177,70
9-2	-005138	50	87	15	15		1	219,30
9-3	-924408	80	113	7	30		1	536,70
9-1-ERS	-243981	Verschleißsteilsatz				9-1	1	121,90
9-2-ERS	-244063	Verschleißsteilsatz				9-2	1	134,40

INFO: Für den Einsatz mit mechanischen KUKKO-Abziehern ab Größe 3.
 For use with mechanical KUKKO-pullers from size 3.

Hydraulischer Radnabenabzieher

ST

10-A



Hydraulic hub puller
 Arrache-moyeux hydraulique
 Hydraulische wielnaaftrekkers
 Ectractor hidráulico para cubos
 Estrattore idraulico per mozzi di ruote
 Hydrauliczny ściągacz piasty koła

Art.-No.		mm	mm	Stk./pcs.	max. t				EUR
10-A	-005626	150	250	6	20		L-Boxx	1	1098,30
10-G	-005701	150	350	7	20		L-Boxx	1	1441,50
10-1	-005213	Hydraulische Presse				10-A, 10-G	-	1	442,60
10-3	-005398	Teilscheibe 250 mm				10-A, 10-G	-	1	270,30
10-5	-005473	Teilscheibe 350 mm				10-G, 10-M	-	1	388,40
10-6	-005541	1 Abzughaken				10-A, 10-G, 10-M	-	1	72,00
10-ERS	-244148	Verschleißsteilsatz				10-A, 10-G	-	1	191,20

Radnabenabzieher
ST

10-M



Hub puller
Arrache-moyeux
Wielnaaftrekkers
Extractor para cubos
Estrattore per mozzo oi ruote
Ściągacz piasty kofa

Art.-No.		mm	mm	x Stk./pcs.		EUR
10-M	-862311	150	350	6	1	823,50

3-armige Abzieher
ST

11-A



3-arm pullers
Extracteurs à 3 bras
3-armige trekkers
Extractores de 3 brazos
Estrattori a 3 bracci
Ściągacze 3-ramienne

Art.-No.		mm	mm	mm		EUR
11-0-A	-005886	375	200	36	1	892,70
11-0-A3	-729263	375	300	36	1	960,50
11-0-A4	-729348	375	400	36	1	995,90
11-0-A5	-729423	375	500	36	1	1036,90
11-1-A	-075421	520	200	41	1	1167,30
11-1-A3	-729591	520	300	41	1	1235,90
11-1-A4	-729676	520	400	41	1	1270,60
11-1-A5	-729751	520	500	41	1	1312,50
11-2-A	-006203	650	200	41	1	1236,00
11-2-A3	-706158	650	300	41	1	1303,60
11-2-A4	-729836	650	400	41	1	1339,40
11-2-A5	-729911	650	500	41	1	1372,50

3-armige Abzieher mit verstellbarer Spanntiefe
ST

11-AV



3-jaw pullers with adjustable reach
Extracteur à 3 bras avec profondeur réglable
3-armige trekkers met instelbare spandiepte
Extractores de 3 brazos con profundidad regulable
Estrattori a 3 bracci con profondità di serraggio regolabile
3-ramienne ściągacz o przestawnej głębokości mocowania

Art.-No.		mm	mm	mm	EUR
11-0-AV	-730078	375	300 - 500	36	1249,70
11-1-AV	-730153	520	300 - 500	41	1524,40
11-2-AV	-730238	650	300 - 500	41	1457,80

3-armige Abzieher mit langer Hydraulikspindel
ST

11-B



hydraulic
TECHNOLOGY

3-jaw puller with long hydraulic spindle
Extracteur à 3 bras avec vis hydraulique longue
3-armige trekkers met lange hydraulische spindel
Extractores de 3 brazos con husillo hidráulico largo
Estrattori universali a 3 bracci con vite idraulica lunga
3-ramienne ściągacze z długim wrzecionem hydraulicznym

Art.-No.		mm	mm	max. t	mit with		EUR
11-0-B	-075346	375	200	15	8-1-B	1	1403,00
11-1-B	-006128	520	200	20	8-2-K	1	1601,40
11-2-B	-006388	650	200	20	8-2-K	1	1836,80
11-3-B	-706073	650	300	20	8-2-K	1	1904,40

3-armige Abzieher mit verstellbarer Spanntiefe und langer Hydraulikspindel

ST

11-BV



3-jaw pullers with adjustable reach and long hydraulic spindle
 Extracteur à 3 bras avec profondeur réglable et vis hydraulique longue
 3-armige trekkers met instelbare spandiepte en lange hydraulische spindel
 Extractores de 3 brazos con profundidad regulable y husillo hidráulico largo
 Estrattori a 3 bracci con profondità di serraggio regolabile e vite idraulica lunga
 3-ramienny ściągacz o przestawnej głębokości mocowania z długim wrzecionem hydr.



Art.-No.				max. t	mit with		EUR
		mm	mm				
11-0-BV	-730313	375	300 - 500	15	8-1-B	1	1854,00
11-1-BV	-730498	520	300 - 500	20	8-2-K	1	2123,10
11-2-BV	-730566	650	300 - 500	20	8-2-K	1	2159,40

Ersatzteile für Baugruppe 8/11

ST

8/11

Replacement parts for assembly 8/11
 Pièces de rechange pour module 8/11
 Onderdelen voor serie 8/11
 Części zamienne do podzespołu 8/11



11-375
 11-520
 11-650



633400
 637350

Art.-No.					Bezeichnung description			EUR
			mm	mm				
633400	-765384	G 1"	400	36	Spindel	18-4, 11-0-A, 11-0-A3, 11-0-A4, 11-0-A5, 11-0-AV	1	165,00
637350	-893469	G1 1/8"	350	36	Spindel	11-1-A, 11-1-A3, 11-1-A4, 11-1-A5, 11-1-AV, 11-2-A, 11-2-A3, 11-2-A4, 11-2-A5, 11-2-AV, 30-40, 30-5	1	220,00
11-375	-035258	-	-	-	Traverse	11-0-A, 11-0-A3, 11-0-A4, 11-0-A5, 11-0-AV, 11-0-B, 11-0-BV	1	575,00
11-520	-035333	-	-	-	Traverse	11-1-A, 11-1-A3, 11-1-A4, 11-1-A5, 11-1-AV, 11-1-B, 11-1-BV	1	900,00
11-650	-035418	-	-	-	Traverse	11-2-A, 11-2-A3, 11-2-A4, 11-2-A5, 11-2-AV, 11-2-B, 11-2-BV, 11-3-B, 30-5	1	900,00

3-armige Abzieher „Alligator“ mit voreinstellbaren Abzughaken

ST

12



3-jaw „alligator“ pullers with pre-settable jaws
 Extracteur « Alligator » à 3 bras avec griffes d'extraction pré réglables
 3-armige trekkers „Alligator“ met vooraf instelbare trekhaken
 Extractores de 3 brazos «Alligator» con ganchos de extracción preajustables
 Estrattori a 3 bracci „Alligator“ con griffe pre regolabili
 3-ramienny ściągacz „Alligator“ z przestawnymi ramionami



Art.-No.						EUR
		mm	mm	mm		
12-1	-006616	100	100	17	1	134,70
12-2	-006791	150	125	19	1	198,20
12-3	-006876	200	165	24	1	288,10

3-armiger Abzieher „Tirax“ mit voreinstellbaren Abzughaken zum Innen- und Außenabziehen
ST

12



3-jaw „Tirax“ puller with pre-settable jaws for inside and outside pulling
 Extracteur « Tirax » à 3 bras avec griffes d'extraction pré réglables avec prise intérieure et extérieure
 3-armige trekkers „TIRAX“ met vooraf instelbare trekhaken voor het in- en uitwendig trekken
 Extractor de 3 brazos «Tirax» con ganchos de extracción preajustables para extracciones interiores y exteriores
 Estrattore a 3“Tirax“ griffe preregolabili per estrazione interna ed esterna
 3-ramienny ściągacz „Tirax“ z wstępnie ustawianymi ramionami do ściągania wewnętrznego i zewnętrznego



Art.-No.						EUR
		mm	mm			
12-4	-850509	250	225	12-A	1	714,10
12-5	-850684	350	275	12-A	1	1732,10
12-6	-850769	450	300	12-B	1	1943,30
12-7	-850844	650	350	-	1	2471,70
12-A	-833373	Pressplatte		12-4, 12-5	1	91,50
12-B	-833458	Pressplatte		12-6	1	137,20

3-armiger Lagerabzieher mit selbstzentrierenden Abzughaken und langer Hydraulikspindel (mit Handhebelbetätigung)
ST

13-HP

3-jaw combination bearing puller with swiveling pulling hook and long hydraulic spindle (with handle)
 Extracteur de roulement combiné à 3 bras avec griffes d'extraction articulées et vis hydraulique longue (à commande par levier manuel)
 3-armige universele hydraulische trekker met pomp bediening
 Extractor combinado de cojinete de tres brazos con ganchos de extracción giratorios y husillo hidráulico largo (con accionamiento de manecilla)
 Estrattore per cuscinetti combi a 3 bracci con griffe scorrevoli e vite idraulica lunga (con comando a leva manuale)
 3-ramienny ściągacz kombinowany do łożysk z przestawnymi ramionami rozwieralnymi i długim wrzecionem hydraulicznym (uruchamianie za pomocą dźwigni)



Art.-No.				max. t	mit		EUR
		mm	mm				
13-HP-100	-101229	50 - 250	250	10	8-HP-100	1	892,00

Trennvorrichtung mit 3 Segmenten
ST

13-TP

Separators with 3 segments
 Dispositif de séparation à 3 segments
 Trekplaten in 3 segmenten
 Separador con tres segmentos
 Separatore a 3 segmenti
 Urządzenie rozdzielające z 3 segmentami

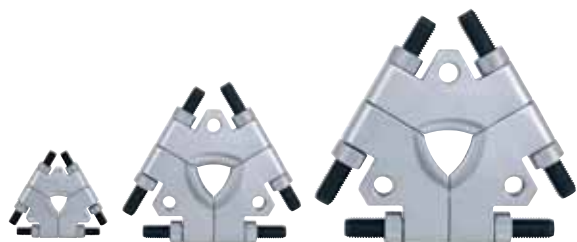

Art.-No.										EUR
		mm								
13-TP-1	-101823	12 - 50	21304 - 22310	C 2205 - C 2210	61801 - 6410	-	-	30-10	1	120,00
13-TP-2	-101830	25 - 100	22205 - 22320	C 2205 - C 2320	61805 - 6320	BT2B 332759 - 617335	NN 4920 - NN 4120	13-ME-180 13-HP-180	1	200,00
13-TP-3	-101847	50 - 160	22211 - 23232	C 2211 - C 3232	61811 - 6232	BT2B 332759 - BT2B 332758	NN 4920 - NN 4132	13-ME-180 13-HP-180	1	300,00





Abziehvorrichtung

ST

13-ME



Pulling device
 Extracteur à tirants
 Hulptrekker
 Dispositivo extractor
 Dispositivo di estrazione
 Narzędzie ściągające

Art.-No.		 mm	 mm			EUR
13-ME-180	-101922	144-300	80-280	13-TP-2; 13-TP-3	1	288,00





Abziehvorrichtung mit hydraulischer Spindel (mit Handhebelbetätigung)

ST

13-HP



Pulling device with hydraulic spindle (with handle)
 Extracteur à tirants à vis hydraulique (à commande par levier manuel)
 Hydraulische hulptrekker met pomp bediening
 Dispositivo extractor con husillo hidráulico (con accionamiento de manecilla)
 Dispositivo di estrazione con vite idraulica (con comando a leva manuale)
 Narzędzie ściągające z wrzecionem hydraulicznym (uruchamianie za pomocą dźwigni ręcznej)

Art.-No.		 mm	 mm	max. t			EUR
13-HP-180	-101250	144-300	80-280	10	13-TP-2; 13-TP-3	1	740,00

2-armige Abzieher mit Schnellverstellung und Kreuzhaken mit Krallenfüßen

ST





14

mm	14-01	14-03	14-1	14-2	14-3
A	11	12	21	29	29
B	9,5	11	9,5	11	11
C	3,5	3,5	3,5	3,5	3,5
D	2,5	3,9	2,5	3,9	3,9



2-jaw pullers with quick adjusting capability and T-jaws with claw feet
 Extracteur à 2 bras avec réglage rapide et crochets en croix à pieds en griffe
 2-armige trekkers met snelverstelling en gekruiste puntige haken
 Extractores de 2 brazos con ajuste rápido y gancho en cruz y pies con garras
 Estrattore a 2 bracci con regolazione rapida e inserzioni incrociate con piedini a gancio
 2-ramienne ściągające z szybką regulacją i ramionami krzyżowymi z pazurami







Art.-No.		 mm	 mm		EUR
14-01	-459559	6 - 100	85	1	144,20
14-03	-460111	5 - 140	160	1	215,90
14-1	-455421	6 - 100	85	1	126,10
14-2	-248443	10 - 140	125	1	162,30
14-3	-248511	15 - 140	160	1	176,30

Trennvorrichtungen
ST

15



Separators
 Décolleurs
 Mestrekkers
 Separadores
 Separatori
 Przyrządy rozdzielające

Art.-No.		 mm	 mm			EUR
15-00	-101854	6 - 40	55	18-00	1	67,90
15-0	-006951	8 - 60	60	18-0	1	72,00
15-1	-007033	12 - 75	75	18-1	1	94,50
15-2	-007118	22 - 115	115	18-2, 18-2-B	1	144,20
15-3	-007293	25 - 155	155	18-3, 18-3-B	1	234,10
15-4	-007378	30 - 200	200	18-4, 18-4-B	1	672,90
15-5	-007453	30 - 250	250	18-5, 18-5-B	1	958,60





Trennvorrichtungs-Sätze
ST

15

 15-A
 15-K

15-B

Separating-sets
 Jeux de décollage
 Mestrekker-sets
 Juegos de separación
 Set di separatori
 Zestawy urządzeń rozdzielających





Art.-No.		 mm		Stück pieces			EUR
15-K	-007941	8-60	15-0, 18-0, 19-1-P	4	i-Boxx	1	237,20
15-A	-007521	12-75	15-1, 18-1, 19-1-P	4	i-Boxx	1	337,80
15-B	-007606	22-115	15-2, 18-2, 19-2-P	4	L-Boxx	1	437,50
15-C	-007781	25-155	15-3, 18-3, 19-3-P	4	Metall	1	629,50
15-D	-007866	30-200	15-4, 18-4, 19-4-P	4	Metall	1	1558,70
15-E	-308826	30-250	15-5, 18-5, 19-5-P	4	Metall	1	2003,10

Zylinderbüchsen-Auszieher
ST

16



Cylinder liner puller
 Extracteur de chemises de cylindre
 Cylinderbus-trekker
 Estractor de camisas de cilindro
 Estrattore per boccole cilindriche
 Ściągacz do tulei cylindrów

Art.-No.		 mm			EUR
16	-008023	60 - 155	16-21, 16-22	1	589,20
16-21	-251559	60 - 155	Innenauszieher	1	389,20
16-22	-251634	-	Gegenstütze	1	283,80

INFOBOX: No. 15 · 17 · 18 · 19

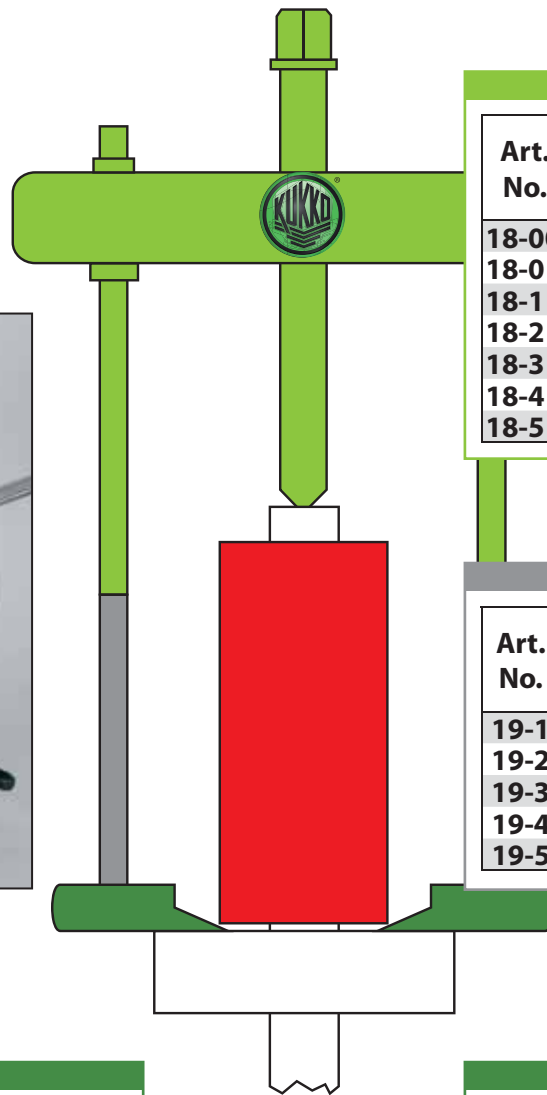

No. 18

Art. No.		
18-00	6- 40	
18-0	50-110	150
18-1	60-150	200
18-2	60-200	250
18-3	80-300	300
18-4	120-380	350
18-5	150-440	400



No. 19

Art. No.	L mm	für for
19-1	100	18-0; 18-1
19-2	100	18-2
19-3	100	18-3
19-4	200	18-4
19-5	200	18-5



No. 15

Art. No.		
	mm	mm
15-00	6-40	55
15-0	8- 60	60
15-1	12- 75	75
15-2	22-115	115
15-3	25-155	155
15-4	30-200	200
15-5	30-250	250



No. 17

Art. No.		
	mm	mm
17-0	8- 60	60
17-1	12- 75	75
17-2	22-115	115
17-3	25-155	155



Sätze / set

15-K	15-A	15-B	15-C	15-D	15-E
15-0	15-1	15-2	15-3	15-4	15-5
18-0	18-1	18-2	18-3	18-4	18-5
19-1	19-1	19-2	19-3	19-4	19-5



Sätze / set

17-K	17-A	17-B	17-C
17-0	17-1	17-2	17-3
18-0	18-1	18-2	18-3
19-1	19-1	19-2	19-3







Zylinderbüchsen-Auszieher-Satz
ST

16-K



Cylinder liner puller set
 Jeu de extracteur de chemises de cylindre
 Cylinderbus-trekker set
 Juego de extractor de camisas de cilindro
 Set di estrattori per boccole cilindriche
 Zestaw ściągaczy do tulei cylindrów





Art.-No.		 mm		Stück pieces			EUR
16-K	-392146	60 - 155	16-21, 16-22	4	Metall	1	710,80

Trennvorrichtungen mit Schnellspanndruckspindel
ST

17



Separators with quick clamping pressure spindle
 Décolleurs avec vis d'extraction de serrage rapide
 Mestrekkers met snelspanspindel
 Separadores con husillo de presión con regulación rápida
 Separatori con vite a serraggio rapido
 Urządzenia rozdzielające z szybko mocującym sworzniem naciskowym

Art.-No.		 mm	 mm			EUR
17-0	-008108	8-60	60	18-0	1	108,10
17-1	-008283	12-75	75	18-1	1	139,60
17-2	-008368	22-115	115	18-2	1	204,50
17-3	-008443	25-155	155	18-3	1	330,80





Trennvorrichtungensätze
ST

17

 17-A
17-K

17-B

Separating-sets
 Jeux de décollage
 Mestrekker-sets
 Juegos de separación
 Set di separatori
 Zestawy urządzeń rozdzielających







Art.-No.		 mm		Stück pieces			EUR
17-K	-008856	8 - 60	17-0, 18-0, 19-1-P	4	i-Boxx	1	295,30
17-A	-008511	12 - 75	17-1, 18-1, 19-1-P	4	i-Boxx	1	337,90
17-B	-008696	22 - 115	17-2, 18-2, 19-2-P	4	L-Boxx	1	497,70
17-C	-008771	25 - 155	17-3, 18-3, 19-3-P	4	Metall	1	687,70

Abziehvorrchtungen
ST

18



Pulling devices
 Extracteurs à tirants
 Hulptrekkers
 Dispositivos extracores
 Dispositivi estrattori
 Ściągacze

Art.-No.		 mm	 mm	 mm	max. t			EUR
18-00	-101939	6 - 40	60	12		15-00	1	61,10
18-0	-075599	71 - 150	50 - 110	13	3	15-0, 17-0	1	64,70
18-1	-075674	122 - 200	60 - 150	19	5	15-1, 17-1	1	108,10
18-2	-075759	125 - 250	60 - 200	22	7	15-2, 17-2	1	157,70
18-3	-005961	144 - 300	80 - 300	27	10	15-3, 17-3	1	273,70
18-4	-006043	134 - 350	120 - 380	36	15	15-4	1	577,90
18-5	-075834	225 - 400	150 - 440	41	20	15-5	1	823,60





2 Verlängerungen für Abziehvorrichtungen

ST

19



2 Extensions for pulling devices (pair)
 2 Rallonges pour dispositifs d'extraction (paire)
 2 Verlengstukken voor hulptrekkers (paar)
 2 Alargaderas para dispositivos extractores (par)
 2 Prolunghe per dispositivi di estrazione (paio)
 2 Przedłużenia do urządzeń ściągających (para)

Art.-No.		 mm			EUR
19-1-P	-169984	100	18-0, 18-1	1	21,80
19-2-P	-170041	100	18-2	1	27,30
19-3-P	-170126	100	18-3	1	32,60
19-4-P	-168321	200	18-4	1	54,10
19-5-P	-152306	200	18-5	1	75,80





Gewindeadapter Satz

ST

18-AS



Set of screw adapters
 Jeu de adapteurs
 Schroefdraadadapters-set
 Juego de adaptadores
 Set di adattatori filettati
 Zestaw adapterów gwintów

Art.-No.					Inhalt content		EUR
18-0-AS	-337048	M4-M5-M6-M8-M10-M12	M10	18-0, 18-1	Satz	1	121,40
18-2-AS	-337123	M8-M10-M12-M14-M16-M18	M14x1,5	18-2	Satz	1	187,80
18-3-AS	-337208	M14-M16-M18-M20-M22-M24	M18x1,5	18-3	Satz	1	264,10





Gewindeadapter (Paar)

ST

18-A



Screw adapters (pair)
 Adapteurs (paire)
 Schroefdraadadapters (paar)
 Adaptadores (par)
 Adattatore filettato (paio)
 Adapter gwintu (par)

Art.-No.					Inhalt content		EUR
18-003A	-788406	M3	M10	18-0, 18-1	Paar	1	26,70
18-004A	-337383	M4	M10	18-0, 18-1	Paar	1	26,00
18-005A	-337468	M5	M10	18-0, 18-1	Paar	1	26,00
18-006A	-337536	M6	M10	18-0, 18-1	Paar	1	36,00
18-008A	-337611	M8	M10	18-0, 18-1	Paar	1	27,90
18-010A	-337796	M10	M10	18-0, 18-1	Paar	1	27,90
18-012A	-337871	M12	M10	18-0, 18-1	Paar	1	28,50
18-016A	-788574	M16	M10	18-0, 18-1	Paar	1	34,50
18-208A	-337956	M8	M14x1,5	18-2	Paar	1	52,80
18-210A	-338113	M10	M14x1,5	18-2	Paar	1	53,60
18-212A	-338298	M12	M14x1,5	18-2	Paar	1	54,30
18-214A	-338373	M14	M14x1,5	18-2	Paar	1	55,50
18-216A	-338458	M16	M14x1,5	18-2	Paar	1	56,10
18-218A	-338526	M18	M14x1,5	18-2	Paar	1	57,60
18-314A	-338601	M14	M18x1,5	18-3	Paar	1	76,20
18-316A	-338786	M16	M18x1,5	18-3	Paar	1	77,50
18-318A	-338861	M18	M18x1,5	18-3	Paar	1	78,20
18-320A	-338946	M20	M18x1,5	18-3	Paar	1	78,70
18-322A	-339028	M22	M18x1,5	18-3	Paar	1	80,00
18-324A	-339103	M24	M18x1,5	18-3	Paar	1	80,70

Hydraulische Abziehvorrichtung (inklusive mechanischer Spindel)

ST

18-B

 hydraulic
TECHNOLOGY

Hydraulic pulling device (including mechanical pressure screw)
 Extracteur à tirants hydraulique (y compris la vis mécanique)
 Hydraulische hulptrekker (inclusief mechanische spindel)
 Dispositivo extractor hidráulico (con husillo mecánico)
 Dispositivo di estrazione idraulico (con vite meccanico)
 Hydrauliczne narzędzie ściągające (z wrzecionem mechanicznym)

Art.-No.		max. t	mit with			EUR
18-2-B	-885723	7	8-01	15-2, 17-2	1	409,80
18-3-B	-885730	10	8-02	15-3, 17-3	1	574,70
18-4-B	-885747	15	8-1-B	15-4	1	1235,60
18-5-B	-885754	20	8-2-M	15-5	1	1716,50

2-armige Universal Abzieher

ST

20



2-arm pullers
 Extracteurs à 2 bras
 2-armige universele trekkers
 Extractores de 2 brazos
 Estrattori universali a 2 bracci
 2-ramienne ściągacze uniwersalne

 Glide & FIX
TECHNOLOGY ARMLOCK
TECHNOLOGY

Art.-No.						EUR
		mm	mm	mm		
20-1	-009433	90	100	17	1	85,20
20-10	-009921	120	100	17	1	92,00
20-2	-009501	160	150	22	1	159,30
20-20	-010088	200	150	22	1	174,40
20-3	-009686	250	200	27	1	291,20
20-30	-010163	350	200	27	1	315,90
20-4	-009761	520	200	36	1	631,70
20-40	-411861	650	300	36	1	1084,90
20-5	-009846	750	400 - 700	41	1	2005,10

KUKKO - Das Original seit 1919

KUKKO ORIGINAL Security Label

Um Kunden vor minderwertigen Plagiaten und Produktpiraterie zu schützen werden KUKKO Werkzeuge ab sofort mit dem fälschungssicheren und patentierten KUKKO ORIGINAL Security Label versehen.



Farbkipp-Effekt

Beim Kippen des Security Labels ändert sich dessen Farbe von Weiss nach Cyan. Der grüne Logodruck verändert seine Farbe jedoch nicht.



Hintergrund Prägung

Die Prägung mit KUKKO Logo und dem Schriftzug "KUKKO" ist erhaben und ändert ebenfalls ihre Farbe beim Kippen des Security Labels. Hier jedoch von Rotgold nach Blau.



Brüchiger Hintergrund

Um zu vermeiden, dass ORIGINAL KUKKO security Label auf Plagiaten angebracht werden, besitzen die Labels einen brüchigen Hintergrund. Beim Ablösen von ORIGINAL KUKKO-Werkzeug wird das Label beschädigt.



2-armige Universal Abzieher mit verlängerten Abzughaken

ST

20



Universal 2-jaw puller with extended jaws
 Extracteur universel à 2 bras avec griffes d'extraction allongées
 2-armige universele trekker met verlengde trekhaken
 Extractores universales de 2 brazos con ganchos de extracción prolongados
 Estrattori universali a 2 bracci con griffe allungate
 2-ramienne ściągacze uniwersalne z przedłużonymi ramionami



Glide & FIX TECHNOLOGY
ARMLOCK TECHNOLOGY

Art.-No.		 mm	 mm	 mm		EUR
20-1-2	-466311	90	200	17	1	114,40
20-1-25	-914362	90	250	17	1	131,80
20-1-4	-989643	90	400	17	1	180,90
20-10-2	-466496	120	200	17	1	121,20
20-10-25	-908682	120	250	17	1	139,30
20-10-4	-989650	120	400	17	1	188,00
20-2-3	-466564	160	300	22	1	204,90
20-20-3	-466649	200	300	22	1	219,50
20-3-25	-901188	250	250	27	1	333,60
20-3-3	-466724	250	300	27	1	357,90
20-3-4	-467066	250	400	27	1	398,50
20-3-5	-467301	250	500	27	1	410,80
20-30-3	-466809	350	300	27	1	385,60
20-30-4	-467141	350	400	27	1	426,00
20-30-5	-467486	350	500	27	1	438,40
20-4-3	-466984	520	300	36	1	694,90
20-4-4	-467226	520	400	36	1	745,40
20-4-5	-467554	520	500	36	1	761,00
20-40-4	-730641	650	400	36	1	1135,40
20-40-5	-731976	650	500	36	1	1148,40

2-armige Universal Abzieher mit langer Hydraulikspindel (inklusive mechanischer Spindel)

ST

20-B



Universal 2-jaw puller with long hydraulic spindle (including mechanical pressure screw)
 Extracteur universel à 2 bras avec vis hydraulique longue (y compris la vis mécanique)
 2-armige universele trekkers met lange hydraulische spindel (inclusief mechanische spindel)
 Extractores universales de 2 brazos con husillo hidráulico largo (con husillo mecánico)
 Estrattori universali a 2 bracci con vite idraulica lunga (con vite meccanico)
 2-ramienne ściągacze uniwersalne z długim wrzecionem hydraulicznym (z wrzecionem mechanicznym)



hydraulic TECHNOLOGY
Glide & FIX TECHNOLOGY
ARMLOCK TECHNOLOGY

Art.-No.		 mm	 mm	max. t	mit with		EUR
20-2-B	-885815	160	150	7	8-01	1	456,50
20-20-B	-885846	200	150	7	8-01	1	474,70
20-3-B	-885891	250	200	10	8-02	1	590,50
20-30-B	-885945	350	200	10	8-02	1	615,20
20-4-B	-885983	520	200	15	8-1-B	1	1249,70
20-40-B	-886010	650	300	15	8-1-B	1	1702,80

2-armige Universal Abzieher mit verlängerten Abzughaken und langer Hydraulikspindel (inklusive mechanischer Spindel) ST

20-B



Universal 2-jaw puller with long hydraulic spindle and extended jaws (incl. mechanical pressure screw)
 Extracteur universel à 2 bras avec vis hydraulique longue et griffes d'extraction allongées (y compris la vis mécanique)
 2-armige universele trekkers met lange hydraulische spindel en verlengde trekhaken (incl. mechanische spindel)
 Extractores universales de 2 brazos con husillo hidr. largo y ganchos de extracción prolongados (con husillo mecánico)
 Estrattori universali a 2 bracci con griffe allungate e vite idraulica lunga (con vite meccanico)
 2-ramienne ściągacze uniwersalne z długim wrzecionem hydr. i przedłużonymi ramionami (z wrzecionem mechanicznym)



Art.-No.		 mm	 mm	max. t	mit with		EUR
20-2-3-B	-885808	160	300	7	8-01	1	519,80
20-20-3-B	-885839	200	300	7	8-01	1	529,40
20-3-3-B	-885860	250	300	10	8-02	1	688,50
20-3-4-B	-885877	250	400	10	8-02	1	717,30
20-3-5-B	-885884	250	500	10	8-02	1	746,00
20-30-3-B	-885914	350	300	10	8-02	1	716,60
20-30-4-B	-885921	350	400	10	8-02	1	740,30
20-30-5-B	-885938	350	500	10	8-02	1	782,90
20-4-3-B	-885952	520	300	15	8-1-B	1	1249,60
20-4-4-B	-885969	520	400	15	8-1-B	1	1278,40
20-4-5-B	-885976	520	500	15	8-1-B	1	1189,10
20-40-4-B	-885990	650	400	15	8-1-B	1	1579,30
20-40-5-B	-886003	650	500	15	8-1-B	1	1543,70

2-armige Universal Abzieher mit verstellbarer Spanntiefe ST

20-AV/20-5



Universal 2-arm pullers with adjustable reach
 Extracteurs universels à 2 bras avec profondeur réglable
 2-armige universele trekkers met instelbare spandiepte
 Extractores universales de 2 brazos von profundidad regulable
 Estrattori universali a 2 bracci con profondità di serraggio regolabile
 2-ramienne ściągacze uniwersalne o przestawnej głębokości mocowania



Art.-No.		 mm	 mm	 mm		EUR
20-4-AV	-706233	520	300 - 500	36	1	897,80
20-40-AV	-973222	650	300 - 500	36	1	1295,30
20-5	-009846	750	400 - 700	41	1	2005,10

2-armige Abzieher mit kurzer Hydraulikspindel ST

20-H



2-jaw puller with short hydraulic spindle
 Extracteur à 2 bras avec vis hydraulique courte
 2-armige trekkers met korte hydraulische spindel
 Extractores de 2 brazos con husillo hidráulico corto
 Estrattori a 2 bracci con vite idraulica corta
 2-ramienne ściągacze z krótkim wrzecionem hydraulicznym







Art.-No.		 mm	 mm	max. t	mit with		EUR
20-3-H	-786839	250	200	10	800	1	685,50
20-30-H	-786914	350	200	10	800	1	715,10

2-armige Universal Abzieher mit verstellbarer Spanntiefe und langer Hydraulikspindel (inklusive mechanischer Spindel) ST

20-H



Universal 2-jaw puller with adjustable reach and long hydraulic spindle (including mechanical pressure screw)
 Extracteur universel à 2 bras avec profondeur réglable et vis hydraulique longue (y compris la vis mécanique)
 2-armige universele trekkers met instelbare spanndiepte en lange hydraulische spindel (inclusief mechanische spindel)
 Extractores universales de 2 brazos con profundidad regulable y husillo hidráulico largo (con husillo mecánico)
 Estrattori universali a 2 bracci con profondità di serraggio regolabile e vite idraulica lunga (con vite meccanico)
 2-ramienne ściągacze uniwersalne o przestawnej głębokości mocowania i z długim wrzecionem hydraulicznym (z wrzecionem mechanicznym)





Art.-No.		 mm	 mm	max. t	mit with		EUR
20-4-H	-227981	520	300 - 500	15	8-1-B	1	1355,00
20-40-H	-732218	650	300 - 500	15	8-1-B	1	1601,90
20-5-H	-228063	750	400 - 700	20	8-2-M	1	2735,00

2-armige Universal Abzieher im Set ST

20-P3



Universal 2-jaw puller, in set
 Jeu d'extracteurs universels à 2 bras
 2-armige universele trekkers in set
 Juego de extractores universales de 2 brazos
 Estrattori universali a 2 bracci in set
 2-ramienne ściągacze uniwersalne w zestawie



Art.-No.		 mm	 mm		EUR
20-10-P3	-267611	120	100-350	1	309,90
20-20-P2	-003004	200	150/300	1	313,40
20-30-P3	-003011	350	200/300/400	1	904,80

Verkaufsdisplay für 2-armige Abzieher ST

20-ST



Sales display for 2-arm pullers
 Stand de vente pour extracteurs à 2 bras
 Verkoopstandaard voor 2-armige trekkers
 Caballete de exhibición para extractores de 2 brazos
 Display di vendita per estrattori a 2 bracci
 Display sprzedażowy do 2-ramiennych ściągaczy

Art.-No.				EUR
20-ST	-010248	20-1, 20-10, 20-2, 20-20, 20-3	1	802,10

INFOBOX: Verlängerungen / Extensions

Problem:

Die Abzughaken sind zu kurz und können so nicht um das abzuziehende Teil greifen.

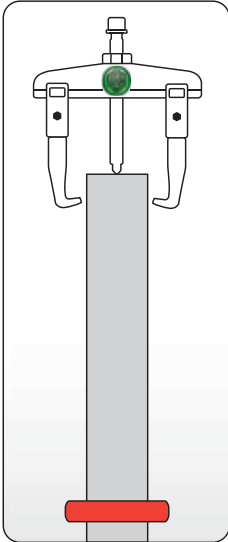

Lösung:

Die KUKKO-Standardabzughaken werden demontiert und mit den Verlängerungen zusammen montiert. Wie viele Verlängerungen in einander montiert werden müssen hängt davon ab, wie tief das abzuziehende Teil sitzt. Das System lässt sich unendlich verlängern und kann so jeder Problemstellung angepasst werden.

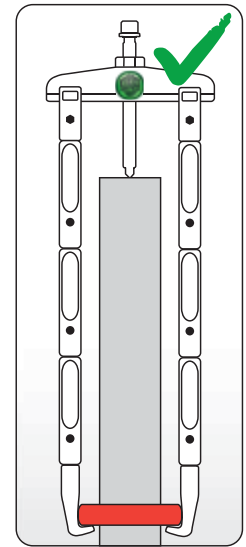
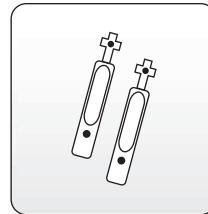
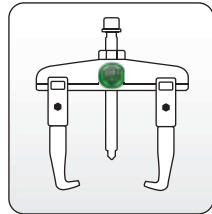

20-1	30-1	100
20-10	30-10	100
20-2	30-2	150
20-20	30-20	150

Art.-No.	mm	für for
1-V-100	100	20-1; 20-10 30-1; 30-10
1-V-150	150	20-1; 20-10 30-1; 30-10
2-V-150	150	20-2; 20-20 30-2; 30-20

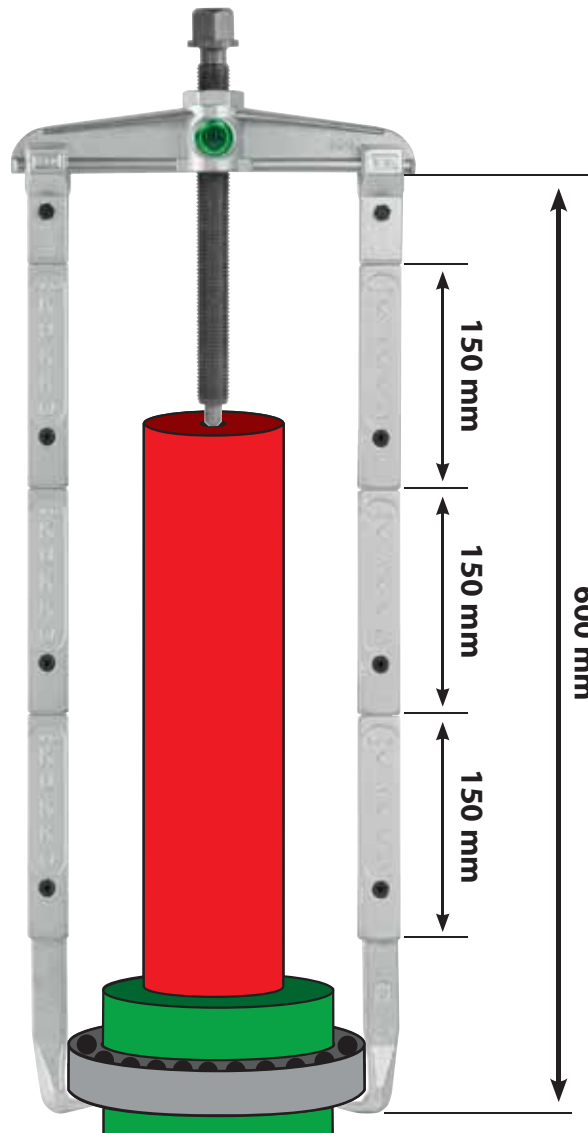

TIPP:

Kombinieren Sie die 2-armigen Abzieher der 20er Baureihe mit der separat erhältlichen Zwinde 219-1 für zusätzlichen Halt am abzuziehenden Teil.

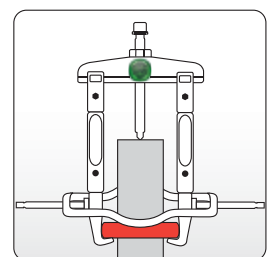
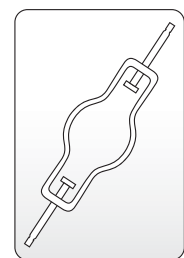

Sie wird nach der Montage des Abziehers zusätzlich an den Abzughaken angebracht und verhindert ein Abrutschen der Abzughaken bei sehr hohen Kräften.





2 Abzughaken (Paar)

ST

O-P

2 pulling arms (pair)
2 griffes d'extraction (paire)
2 trekhaken (paar)
2 ganchos de extracción (par)
2 griffe (paio)
2 ramiona (para)



Art.-No.	 4021176	 mm			EUR
1-90-P	-001338	100	20-1, 20-10	1	48,40
2-150-P	-002403	150	20-2, 20-20	1	90,40
3-200-P	-003233	200	20-3, 20-30, 20-4, 20-40	1	191,90
1-190-P	-001666	200	20-1, 20-10	1	89,20
1-250-P	-001901	250	20-1, 20-10	1	102,60
2-300-P	-002731	300	20-2, 20-20	1	163,40
3-300-P	-003561	300	20-3, 20-30, 20-4, 20-40	1	233,50
3-400-P	-003806	400	20-3, 20-30, 20-4, 20-40	1	254,30
3-500-P	-004148	500	20-3, 20-30, 20-4, 20-40	1	280,60





2 Abzughakenverlängerungen (Paar)

ST

V-P

2 jaw extensions (pair)
2 rallonges de griffes (paire)
2 trekhaakverlengstukken (paar)
2 prolongaciones de ganchos de extracción (par)
2 prolunghe griffe (paio)
2 przedłużenia ramion (para)



Art.-No.	 4021176	 mm			EUR
1-V-100-P	-985058	100	20-1, 20-10	1	40,80
1-V-150-P	-985089	150	20-1, 20-10	1	54,10
2-V-150-P	-985201	150	20-2, 20-20	1	72,90





2 Abzughaken mit verstellbarer Länge (Paar)

ST

SP-P

2 pulling arms with adjustable length (Pair)
2 griffes d'extraction à longueur réglables (paire)
2 in lengte verstelbare trekhaken (paar)
2 ganchos de extracción con longitud ajustable (par)
2 griffe con lunghezza regolabile (paio)
2 ramiona o przestawnej długości (para)



Art.-No.	 4021176	 mm			EUR
4-SP-P	-004636	300-500	20-3, 20-30, 20-4, 20-40	1	480,70
5-SP-P	-004971	400-700	20-5	1	873,00

Universal Abzieh- und Trennvorrichtungssatz
ST

K-20-15



Universal puller set with separator
 Jeu d'extracteurs universels avec décolleur
 Universeel trekker en mestrekker set
 Juego de extractores y dispositivo extractor
 Set di estrattori universali e separatore
 Zestaw uniwersalnych urządzeń ściągających i rozdzielających



Art.-No.	4021176	mm	mm	mm				EUR
K-20-15	-367311	90 - 160	100 - 300	22 - 115	20-1+, 20-2+, 1-192-P, 2-302-P, 15-2, 18-2, 8-01, 600-17	2 x L-Boxx	1	1030,00

2- und 3-armiger Universal Abzieher-Satz
ST

K-2030-10



Sets of universal 2- and 3-arm pullers
 Jeux d'extracteurs universels à 2- et 3 bras
 2- en 3-armige universele trekkers-set
 Juegos de extractores universales de 2 y 3 brazos
 Set di estrattori universali a 2 e 3 bracci
 Zestawy uniwersalnych ściągaczy 2- i 3-ramiennych



Art.-No.	4021176	mm	mm				EUR
K-2030-10	-974748	120 - 130	100 - 350	20-10-P3, 30-10-P3, 614250	L-Boxx	1	576,80

PKW Abziehwerkzeug-Satz
ST

K-20204



Set of pulling tools for passenger cars
 Jeu d'extracteurs pour véhicules de tourisme
 Set personenwagen trekgereedschap
 Juego de extractores para automóviles
 Set di dispositivi di estrazione per automobili
 Zestaw narzędzi ściągających do samochodów osobowych



Art.-No.	4021176		Stück pieces			EUR
K-20204	-744433	20-10, 20-2, 1-91-P, 1-250-P, 2-300-P, 204-0, 129-0, 43-1	11	Metall	1	1020,40



LKW-Abziehwerkzeug-Satz

ST

K-20210



Set of pulling tools for trucks
 Jeu d'extracteurs pour camions
 Set vrachtwagen trekgereedschap
 Juego de extractores para camiones
 Set di dispositivi di estrazione per autocarri
 Zestaw narzędzi ściągających do samochodów ciężarowych

Art.-No.			Stück pieces			EUR
K-20210	-744501	20-20, 2-300-P, 128-3, 128-4, 210-2, Y-09-17, Y-10-17, Y-14-17	9	Metall	1	1183,20

2-armige Universal Abzieher mit schmalen Abzughaken

ST

20-S



Universal 2-jaw puller with narrow jaws
 Extracteur universel à 2 bras avec griffes d'extraction minces
 2-armige universele trekkers met dunne trekhaken
 Extractores universales de 2 brazos con ganchos de extracción finos
 Estrattori universali a 2 bracci con griffe sottili
 2-ramienne ściągacze uniwersalne z wąskimi ramionami

Art.-No.						EUR
		mm	mm	mm		
20-1-S	-757396	90	100	17	1	113,70
20-10-S	-757471	120	100	17	1	121,90
20-2-S	-727368	160	150	22	1	206,90
20-20-S	-727443	200	150	22	1	223,20
20-3-S	-727511	250	200	27	1	369,90
20-30-S	-727696	350	200	27	1	395,60



2-armige Universal Abzieher mit schmalen Abzughaken im Set

ST

20-SP



2-jaw puller with narrow jaw, in set
 Jeu d'extracteurs universels à 2 bras avec griffes d'extraction minces
 2-armige universele trekkers met dunne haken in set
 Juego de extractores universales de 2 brazos con ganchos de extracción finos
 Estrattori universali a 2 bracci con griffe sottili in set
 2-ramienny ściągacz uniwersalny z wąskimi ramionami w zestawie

Art.-No.						EUR
		mm	mm	mm		
20-10-SP	-461514	120	100 - 350	17	1	325,40
20-20-SP	-701856	200	150 - 300	22	1	388,90
20-30-SP	-701931	350	200 - 400	27	1	1030,40



Verkaufsdisplay für 2-armige Abzieher mit schmalen Abzughaken
ST

20-ST-S



Sales display for 2-jaw puller with narrow jaws
 Stand de vente pour extracteur à 2 bras avec griffes d'extraction minces
 Verkoopdisplay voor 2-armige trekkers met dunne trekhaken
 Caballete de exhibición para extractores de 2 brazos con ganchos de extracción finos
 Display di vendita per estrattori a 2 bracci con griffe sottili
 Display sprzedażowy do 2-ramiennych ściągaczy z wąskimi ramionami



Art.-No.				EUR
20-ST-S	-906282	20-1-S, 20-10-S, 20-2-S, 20-20-S, 20-3-S	1	1035,50

2 schmale Abzughaken (Paar)
ST

1-P

2 narrow jaws (pair)
 2 griffes d'extraction minces (paire)
 2 dunne trekhaken (paar)
 2 ganchos de extracción finos (par)
 2 griffe sottili (paio)
 2 wąskie ramiona (para)



1-91-P
 2-151-P
 3-201-P

1-191-P
 1-251-P
 1-401-P
 2-301-P
 3-301-P
 3-401-P
 3-501-P



Art.-No.		 mm			EUR
1-91-P	-434716	100	20-1-S, 20-10-S	1	65,10
1-191-P	-461286	200	20-1-S, 20-10-S	1	105,90
1-251-P	-461446	250	20-1-S, 20-10-S	1	119,20
1-401-P	-985010	400	20-1-S, 20-10-S	1	150,70
2-151-P	-702921	150	20-2-S, 20-20-S	1	150,70
2-301-P	-703188	300	20-2-S, 20-20-S	1	223,60
3-201-P	-726521	200	20-3-S, 20-30-S, 20-4, 20-40	1	219,40
3-301-P	-726781	300	20-3-S, 20-30-S, 20-4, 20-40	1	259,90
3-401-P	-726941	400	20-3-S, 20-30-S, 20-4, 20-40	1	301,80
3-501-P	-727108	500	20-3-S, 20-30-S, 20-4, 20-40	1	438,20

2- und 3-armiger Universal-Abzieher-Satz mit schmalen Abzughaken
ST

K-2030-10-S



Set of two- and three-arm pullers with narrow jaws
 Jeu d'extracteurs universels à 2- et 3 bras avec griffes d'extraction minces
 2- en 3-armige universele trekker-set met dunne trekhaken
 Juego de extractores universales de 2 y 3 brazos con ganchos de extracción finos
 Set di estrattori universali a 2 e 3 bracci con griffe sottili
 Zestaw uniwersalnego ściągacza 2- i 3-ramiennego z wąskimi ramionami



Art.-No.		 mm	 mm				EUR
K-2030-10-S	-306181	120 - 130	100 - 350	20-10-SP, 30-10-SP, 614250	L-Boxx	1	656,40

2-armige Universal Abzieher mit extrem schmalen Abzughaken





ST

20-S-T



Universal 2-jaw puller with extremely narrow jaws
 Extracteur universel à 2 bras avec griffes d'extraction extramincées
 2-armige universele trekkers met extreem dunne trekhaken
 Extractores universales de 2 brazos con ganchos de extracción extrafinos
 2 estrattori universali a 2 bracci con griffe estremamente sottili
 2-ramienny ściągacz uniwersalny z bardzo wąskimi ramionami



Art.-No.		 mm	 mm		EUR
20-1-S-T	-321641	90	100	1	113,70
20-10-S-T	-201097	120	100	1	121,90

2-armiger Abzieher mit extrem schmalen Abzughaken im Set





ST

20-SP-T



2-jaw puller with extremely narrow jaws, in set
 Jeu d'extracteurs à 2 bras avec griffes d'extraction extramincées
 2-armige trekkers met extreem dunne trekhaken in set
 Juego de extractor de 2 brazos con ganchos de extracción extrafinos
 2 estrattori universali a 2 bracci con griffe estremamente sottili in set
 2-ramienny ściągacz z bardzo wąskimi ramionami w zestawie



Art.-No.		 mm	 mm		EUR
20-10-SP-T	-321658	120	100 - 350	1	325,40





2 extrem schmale Abzughaken (Paar)

ST

4-P

2 extremely narrow jaws (pair)
 2 griffes d'extraction extramincées (paire)
 2 extreem dunne trekhaken (paar)
 2 ganchos de extracción extrafinos (par)
 2 griffe estremamente sottili (paio)
 2 bardzo wąskie ramiona (para)



Art.-No.		 mm			EUR
1-94-P	-852039	100	20-1-S-T, 20-10-S-T	1	65,10
1-194-P	-321399	200	20-1-S-T, 20-10-S-T	1	105,90
1-254-P	-321498	250	20-1-S-T, 20-10-S-T	1	119,20





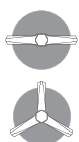

2- und 3-armiger Universal-Abzieher-Satz mit extrem schmalen Abzughaken
ST

K-2030-10-S-T



Set of universal 2- and 3-arm pullers with extremely narrow jaws
 Jeu d'extracteurs universels à 2- et 3 bras avec griffes d'extraction extramincées
 2- en 3-armige universele trekker-set met extreem dunne trekhaken
 Juego de extractores universales de 2 y 3 brazos con ganchos de extracción extrafinos
 Set di estrattori universali a 2 e 3 bracci con griffe estremamente sottili
 Zestaw uniwersalnego cęci'gacza 2- i 3-ramiennego z bardzo wąskimi ramionami



Art.-No.		 mm	 mm				EUR
K-2030-10-S-T	-852022	120 - 130	100 - 350	20-10-SP-T, 30-10-SP-T, 614250	L-Boxx	1	656,40





2-armige Universal Abzieher mit schnellverstellbaren Abzughaken
ST

20+



Universal 2-jaw puller with quick adjusting jaws
 Extracteur universel à 2 bras avec griffes d'extraction à réglage rapide
 2-armige universele trekkers met snel verstelbare trekhaken
 Extractores universales de 2 brazos con ganchos de extracción regulables rápidamente
 Estrattori universali a 2 bracci con griffe a regolazione rapida
 2-ramienne ściągacze uniwersalne z szybkoprzestawnymi ramionami



Art.-No.		 mm	 mm	 mm		EUR
20-1+	-644771	90	100	17	1	99,30
20-10+	-644856	120	100	17	1	107,40
20-2+	-644931	160	150	22	1	181,20
20-20+	-645013	200	150	22	1	204,70
20-3+	-645198	250	200	27	1	330,30
20-30+	-645273	350	200	27	1	353,10





2-armige Universal Abzieher mit schnellverstellbaren Abzughaken und langer Hydraulikspindel (inklusive mechanischer Spindel)
ST

20+B



Universal 2-jaw puller with long hydraulic spindle and quick adjusting jaws (including mechanical pressure screw)
 Extracteur universel à 2 bras avec vis hydraulique longue et griffes d'extraction à réglage rapide (y compris la vis mécanique)
 2-armige universele trekkers met snel verstelbare trekhaken en lange hydraulische spindel (inclusief mechanische spindel)
 Extractores universales de 2 brazos con husillo hydr. largo y ganchos de extracción regulables rápidamente (con husillo mecánico)
 Estrattori universali a 2 bracci con griffe a regolazione rapida e vite idraulica lunga (con vite meccanico)
 2-ramienne ściągacze uniwersalne z długim wrzecionem hydr. i szybkoprzestawnymi ramionami (z wrzecionem mechanicznym)



Art.-No.		 mm	 mm	max. t	mit with		EUR
20-2+B	-885792	160	150	7	8-01	1	465,50
20-20+B	-885822	200	150	7	8-01	1	483,70
20-3+B	-885853	250	200	10	8-02	1	611,90
20-30+B	-885907	350	200	10	8-02	1	640,80



Verkaufsdisplay für 2-armige Abzieher

ST

20-ST+



Sales display for 2-arm pullers
 Stand de vente pour extracteurs à 2 bras
 Verkoopstandaard voor 2-armige trekkers
 Caballete de exhibición para extractores de 2 brazos
 Display di vendita per estrattori a 2 bracci
 Display sprzedażowy do 2-ramiennych ściągaczy

Art.-No.			Stück pieces		EUR
20-ST+	-668944	20-1+, 20-10+, 20-2+, 20-20+, 20-3+	5	1	922,80





2 schnellverstellbare Abzughaken (Paar)

ST

2-P



2 quick adjusting jaws (pair)
 2 griffes d'extraction à réglage rapide (paire)
 2 snel verstelbare trekhaken (paar)
 2 ganchos de extracción regulables rápidamente (par)
 2 griffe a regolazione rapida (paio)
 2 szybkoprzestawne ramiona (para)

Art.-No.		 mm			EUR
1-92-P	-732393	100	20-1+, 20-10+	1	51,20
1-192-P	-973611	200	20-1+, 20-10+	1	95,10
1-252-P	-973673	250	20-1+, 20-10+	1	108,70
2-152-P	-973765	150	20-2+, 20-20+	1	96,40
2-302-P	-973819	300	20-2+, 20-20+	1	170,40
3-202-P	-732706	200	20-3+, 20-30+, 20-4, 20-40	1	198,30
3-302-P	-973932	300	20-3+, 20-30+, 20-4, 20-40	1	255,10
3-402-P	-974014	400	20-3+, 20-30+, 20-4, 20-40	1	269,10
3-502-P	-974137	500	20-3+, 20-30+, 20-4, 20-40	1	292,00

2-armige Universal Abzieher mit schmalen, schnellverstellbaren Abzughaken ST

20+S



Universal 2-jaw puller with narrow, quick adjusting jaws
 Extracteur universel à 2 bras avec avec griffes d'extraction minces à réglage rapide
 2-armige universele trekkers met dunne, snel verstellbare trekhaken
 Extractores universales de 2 brazos con ganchos de extracción finos regulables rápidamente
 Estrattori universali a 2 bracci con griffe sottili, a regolazione rapida
 2-ramienne ściągacze uniwersalne z wąskimi, szybkoprzestawnymi ramionami



Art.-No.						EUR
	4021176	mm	mm	mm		
20-1+S	-756221	90	100	17	1	124,50
20-10+S	-756306	120	100	17	1	132,20
20-2+S	-756481	160	150	22	1	225,50
20-20+S	-756559	200	150	22	1	242,60
20-3+S	-756634	250	200	27	1	401,60
20-30+S	-756719	350	200	27	1	424,50

2 schmale, schnellverstellbare Abzughaken (Paar) ST

3-P

2 narrow, quick adjusting jaws (pair)
 2 griffes d'extraction minces à réglage rapide (paire)
 2 dunne, snel verstellbare trekhaken (paar)
 2 ganchos de extracción finos regulables rápidamente (par)
 2 griffe sottili, a regolazione rapida (paio)
 2 wąskie, szybkoprzestawne ramiona (para)



1-93-P
 2-153-P
 3-203-P

1-193-P
 1-253-P
 2-303-P
 3-303-P
 3-403-P
 3-503-P



Art.-No.					EUR
	4021176	mm			
1-93-P	-973352	100	20-1+S, 20-10+S	1	76,40
1-193-P	-973642	200	20-1+S, 20-10+S	1	97,00
1-253-P	-973710	250	20-1+S, 20-10+S	1	115,60
2-153-P	-973789	150	20-2+S, 20-20+S	1	140,00
2-303-P	-973857	300	20-2+S, 20-20+S	1	171,20
3-203-P	-973901	200	20-3+S, 20-30+S, 20-4, 20-40	1	235,10
3-303-P	-973970	300	20-3+S, 20-30+S, 20-4, 20-40	1	294,80
3-403-P	-974052	400	20-3+S, 20-30+S, 20-4, 20-40	1	328,30
3-503-P	-974175	500	20-3+S, 20-30+S, 20-4, 20-40	1	463,50

2-armige Universal Abzieher mit extrem schmalen, schnellverstellbaren Abzughaken ST

20+ST



Universal 2-jaw puller with extremely narrow, quick adjusting jaws
 Extracteur universel à 2 bras avec griffes d'extraction extraminces à réglage rapide
 2-armige universele trekkers met extreem dunne, snel verstellbare trekhaken
 Extractores universales de 2 brazos con ganchos de extracción extrafinos regulables rápidamente
 Estrattori universali a 2 bracci con griffe estremamente sottili, a regolazione rapida
 2-ramienne ściągacze uniwersalne z bardzo wąskimi, szybkoprzestawnymi ramionami



Art.-No.					EUR
	4021176	mm	mm		
20-1+S-T	-321344	90	100	1	124,50
20-10+S-T	-321368	120	100	1	132,20





2 extrem schmale, schnellverstellbare Abzughaken (Paar)

ST

5-P



2 extremely narrow, quick adjusting jaws (pair)
 2 griffes d'extraction extraminces à réglage rapide (paire)
 2 extreem dunne, snel verstellbare trekhaken (paar)
 2 ganchos de extracción extrafinos regulables rápidamente (par)
 2 griffe estremamente sottili, a regolazione rapida (paio)
 2 bardzo wąskie, szybkoprzestawne ramiona (para)

Art.-No.		 mm			EUR
1-95-P	-321610	100	20-1+S, 20-10+S	1	76,40
1-195-P	-321443	200	20-1+S, 20-10+S	1	97,00
1-255-P	-321542	250	20-1+S, 20-10+S	1	115,60





2-armiger Abzieher für Getriebezahnräder

ST

20



2-arm puller
 Extracteur à 2 bras
 2-armige trekker voor tandwielen versnellingsbak
 Extractor de 2 brazos
 Estrattore a 2 bracci per ruote dentate del cambio
 2-ramienny ściągacz do przekładniowych kół zębatych

Art.-No.		 mm	 mm		EUR
20-10-V	-907944	120	100	1	191,90
1-96/219-V	-793073	2 Abzughaken mit Spannzwinde		1	165,00

Kombination von Gegenstütze mit 2- und 3-schaligen Innenauszieher, Serie 21

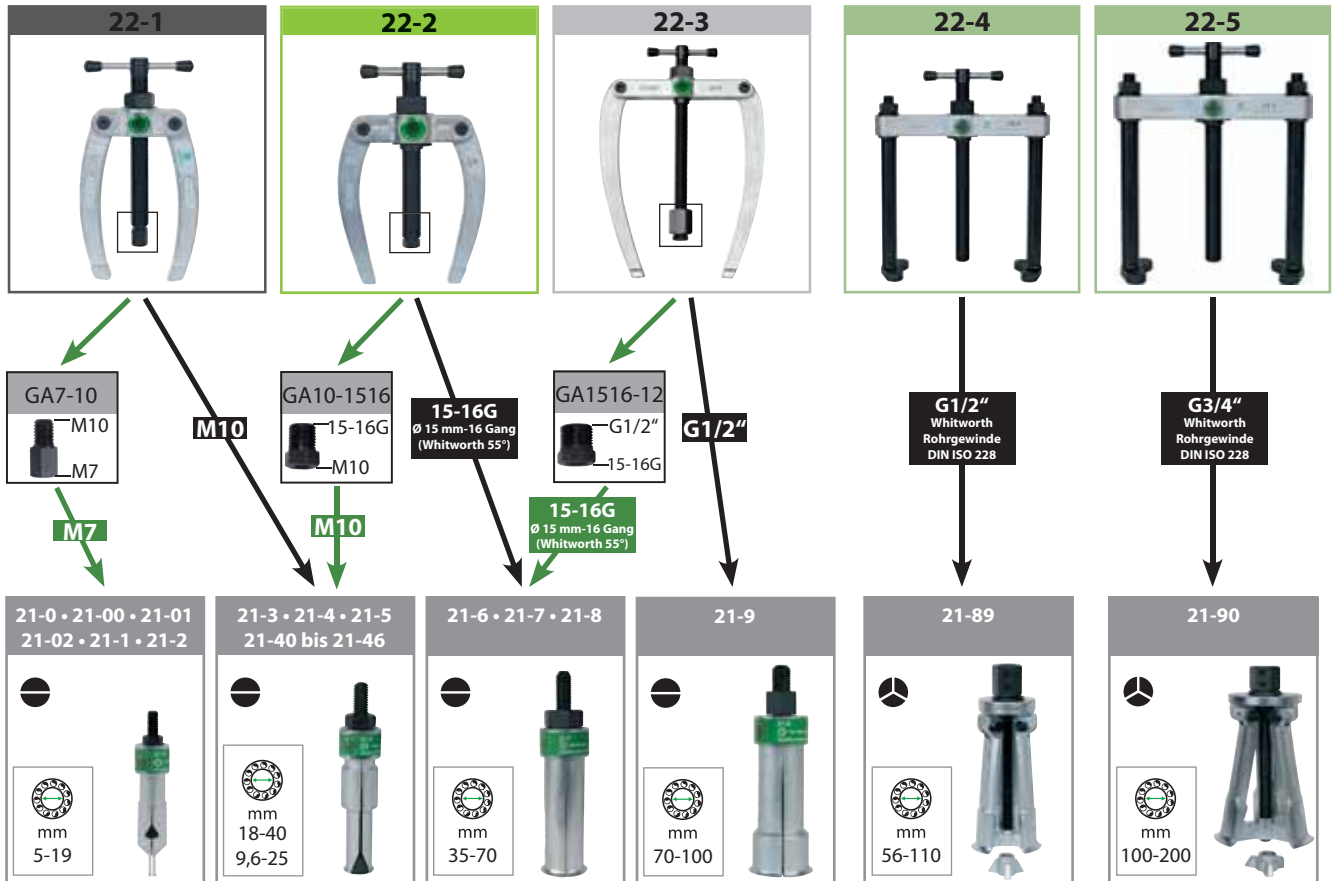

Kombination von Gleithammer mit 2- und 3-schaligen Innenauszieher, Serie 21

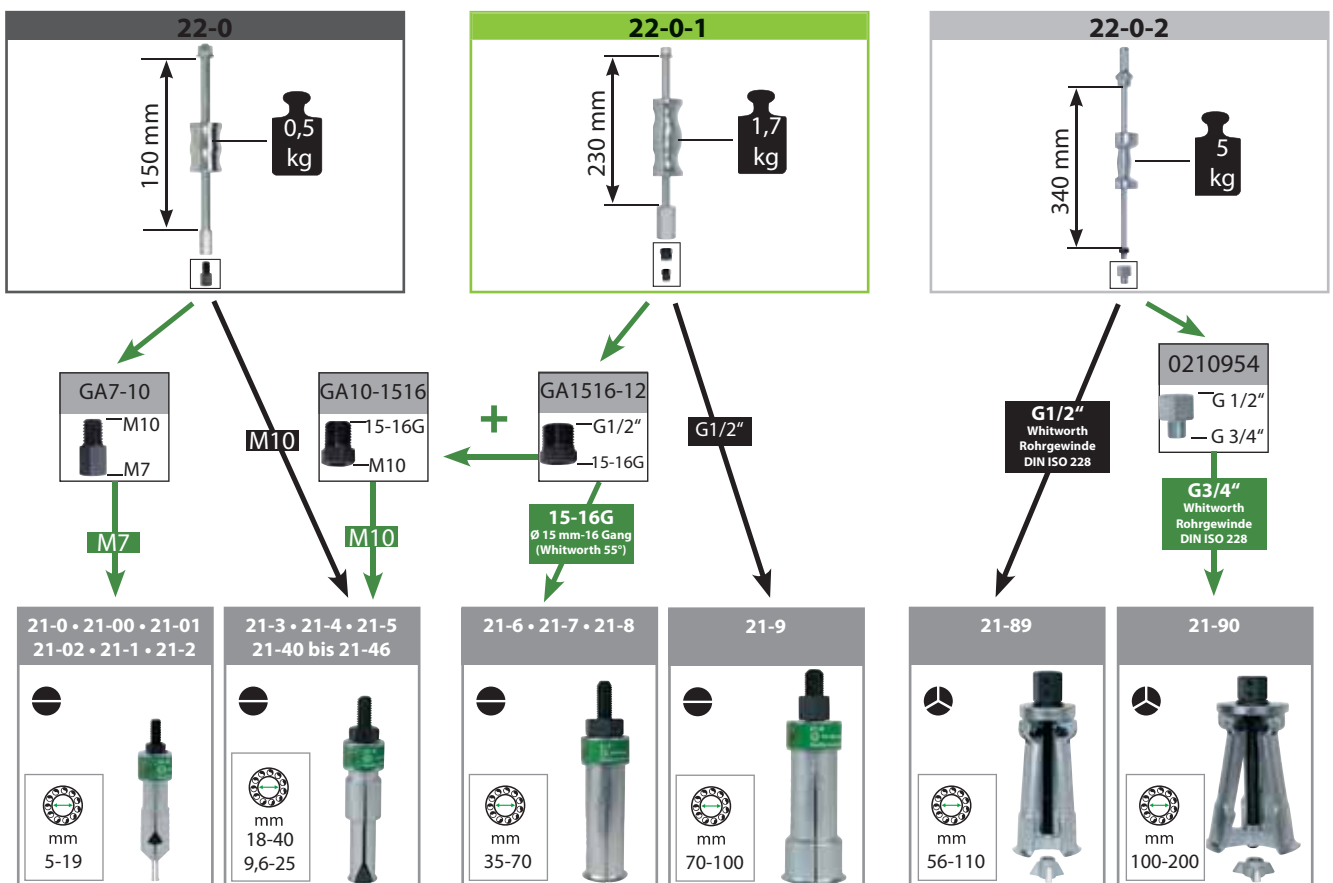

Kombination von Gegenstütze mit Innenauszieher mit Segmentspannung, Serie 21-E

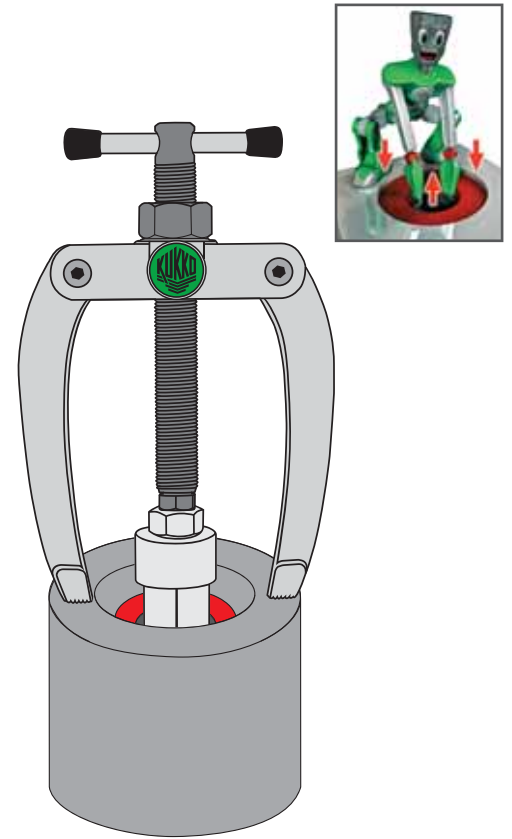
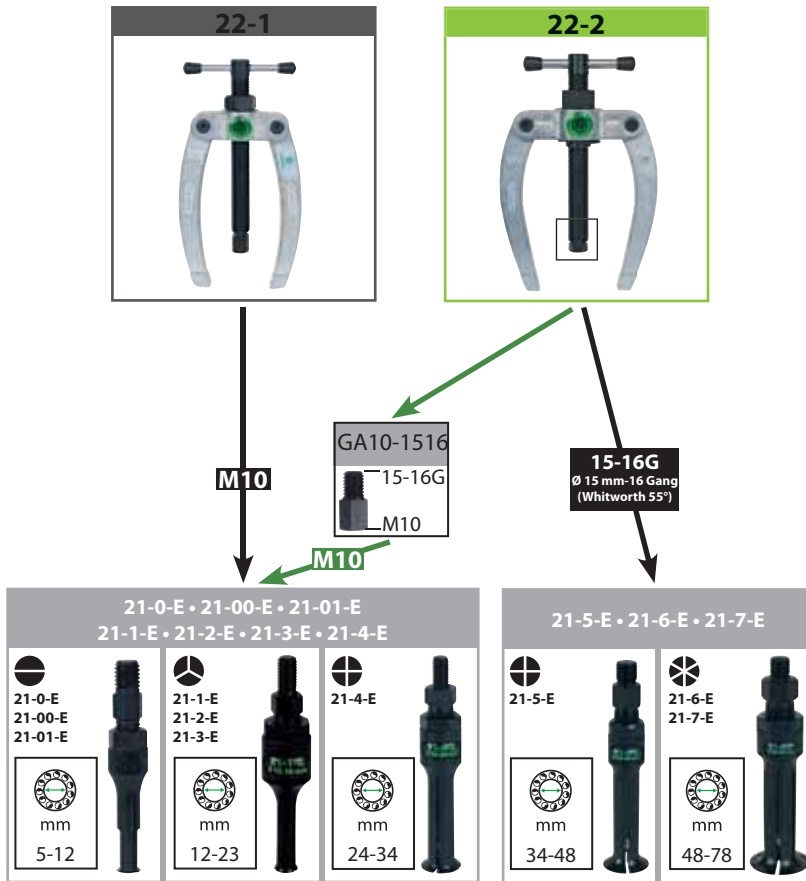

Kombination von Gleithammer mit Innenauszieher mit Segmentspannung, Serie 21-E

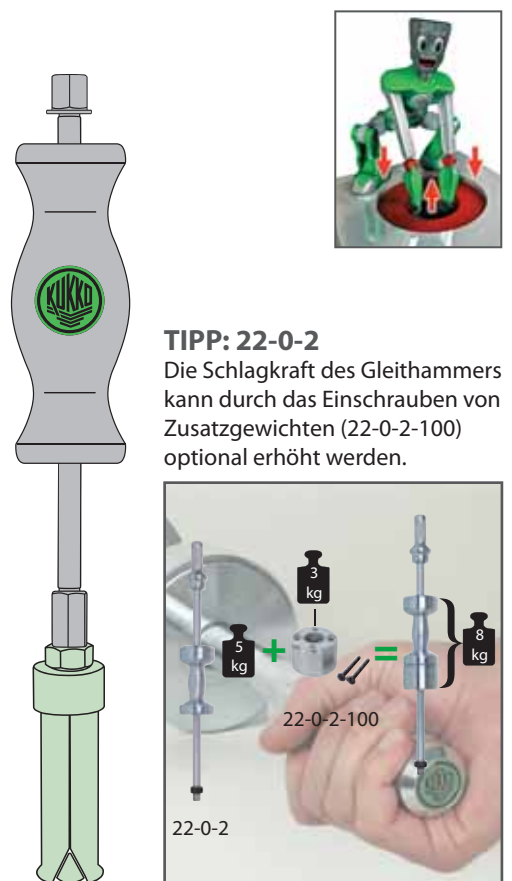
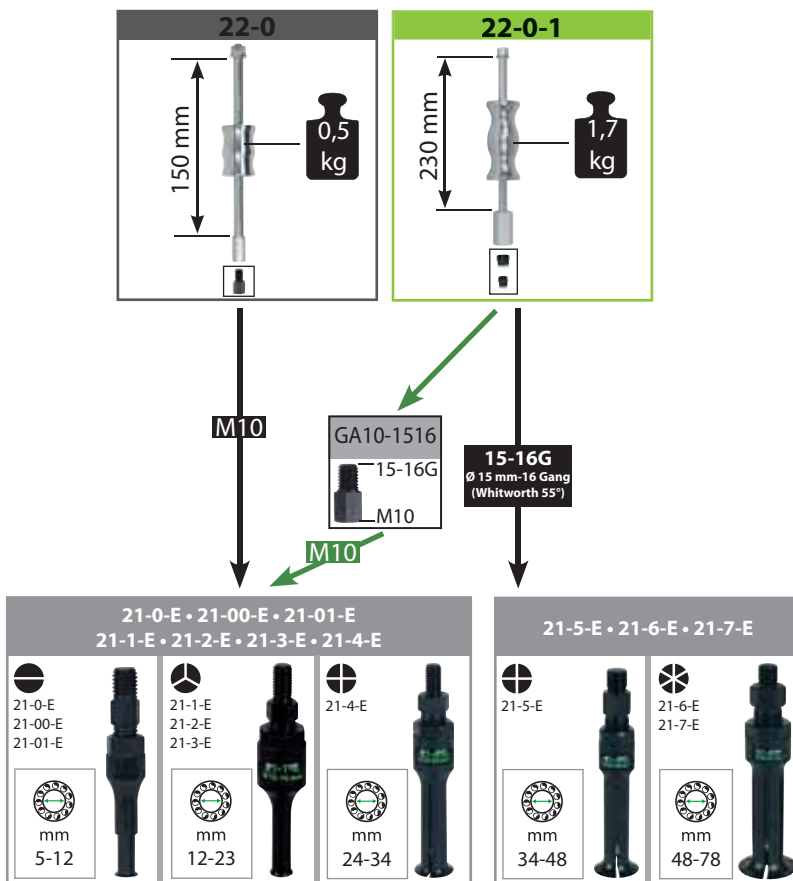

2- und 3-schalige Innenauszieher
ST

21

Internal extractors
 Extracteurs intérieurs
 Binnentrekkers met 2 en 3 schalen
 Extractores interiores
 Estrattori interni a 2 e 3 strati
 2- i 3-powłokowe ściągacze wewnętrzne

























21-0
21-00
21-01
21-02

21-1
21-2
21-3
21-4
21-5
21-6

21-7
21-8
21-9

21-89
21-90















Art.-No.		 mm	 mm	 mm	 Segment			EUR
21-0	-010408	5 - 8	14	73		22-1, 22-0	1	61,80
21-00	-010576	6 - 10	14	73		22-1, 22-0	1	61,80
21-01	-010651	8 - 12	14	73		22-1, 22-0	1	61,80
21-02	-010736	10 - 14	14	73		22-1, 22-0	1	61,80
21-1	-010811	12 - 16	25	72		22-1, 22-0	1	61,80
21-2	-010996	14 - 19	27	72		22-1, 22-0	1	61,80
21-3	-011153	18 - 23	35	89		22-1, 22-2, 22-0-1, 22-0	1	61,80
21-4	-011238	20 - 30	40	92		22-1, 22-2, 22-0-1, 22-0	1	68,30
21-5	-011498	28 - 40	23	101		22-1, 22-2, 22-0-1, 22-0	1	76,70
21-6	-011566	35 - 46	50	113		22-2, 22-3, 22-0-1	1	85,30
21-7	-011641	45 - 58	85	135		22-2, 22-3, 22-0-1	1	115,10
21-8	-011726	56 - 70	85	133		22-2, 22-3, 22-0-1	1	145,00
21-9	-011986	70 - 100	95	166		22-3, 22-0-1	1	230,30
21-89	-011801	56 - 110	120	185		22-4, 22-0-2	1	332,60
21-90	-012068	100 - 200	175	220		22-5, 22-0-2	1	435,00

2-schalige Nadellager-Auszieher
ST

21-4

Needle bearing extractors
 Extracteurs roulements à aiguilles
 Naaldlager binnentrekkers
 Extractores de cojinetes agujas
 Estrattori a 2 strati per cuscinetti a rullini
 2-powłokowe ściągacze do łożysk igielkowych



Art.-No.		 mm	 mm	 mm	 Segment			EUR
21-40	-411526	9,6 - 18	18	92		22-1, 22-2, 22-0-1, 22-0	1	109,90
21-41	-186066	11,5 - 19	18	92		22-1, 22-2, 22-0-1, 22-0	1	109,90
21-42	-186141	12,5 - 21	19	92		22-1, 22-2, 22-0-1, 22-0	1	109,90
21-43	-186226	14,5 - 22	19	92		22-1, 22-2, 22-0-1, 22-0	1	109,90
21-44	-186301	16,5 - 23	23	92		22-1, 22-2, 22-0-1, 22-0	1	109,90
21-45	-186486	18,5 - 24	23	92		22-1, 22-2, 22-0-1, 22-0	1	109,90
21-46	-186554	20 - 25	23,5	92		22-1, 22-2, 22-0-1, 22-0	1	109,90

















Segment-Innenauszieher

ST

21-E



Segmented internal extractor
 Extracteur intérieur pour segments
 Segment-binnentrekker
 Extractor interior de segmentos
 Estrattore interno per segmento
 Segmentowe ściągacze wewnętrzne

Art.-No.	 4021176	 mm	 mm	 mm	 Segment			EUR
21-0-E	-909153	4,8 - 6,5	30	54		22-0, 22-0-1, 22-1, 22-2	1	61,80
21-00-E	-909160	6,8 - 9,5	30	54		22-0, 22-0-1, 22-1, 22-2	1	61,80
21-01-E	-909177	9,5 - 12,5	30	54		22-0, 22-0-1, 22-1, 22-2	1	61,80
21-1-E	-930003	12 - 16	35	80		22-0, 22-0-1, 22-1, 22-2	1	61,80
21-2-E	-931000	14 - 19	40	83		22-0, 22-0-1, 22-1, 22-2	1	61,80
21-3-E	-931109	18 - 23	50	90		22-0, 22-0-1, 22-1, 22-2	1	61,80
21-4-E	-909191	24 - 34	58	98		22-0, 22-0-1, 22-1, 22-2	1	68,30
21-5-E	-924071	34 - 48	65	110		22-2, 22-0-1	1	76,70
21-6-E	-924088	48 - 63	80	120		22-2, 22-0-1	1	85,30
21-7-E	-924095	63 - 78	80	120		22-2, 22-0-1	1	115,10





Verlängerungen für Innenauszieher

ST

21-V



Extensions for internal extractors
 Ralongs pour extracteurs intérieurs
 Binnentrekker verlengstukken
 Alargaderas para extractores interiores
 Prolunghe per estrattori interni
 Przedłużenia do ściągaczy wewnętrznych

Art.-No.	 4021176	 L mm			EUR
21-V-040	-909214	40	21-0, 21-00, 21-01, 21-02, 21-2	1	29,40
21-V-060	-909221	60	21-0, 21-00, 21-01, 21-02, 21-2	1	34,00
21-V-080	-909238	80	21-0, 21-00, 21-01, 21-02, 21-2	1	39,00
21-V-310	-914386	100	21-3, 21-4, 21-5, 21-40, 21-41, 21-42, 21-43, 21-44, 21-45, 21-46	1	47,40







Satz Verlängerungen für Innenauszieher

ST

21-V



Set of extensions for internal extractors
 Jeu de ralongs pour extracteurs intérieurs
 Binnentrekker verlengstukken-set
 Juego de alargaderas para extractores interiores
 Set di prolunghe per estrattore interno
 Zestaw przedłużaczy do ściągaczy wewnętrznych

Art.-No.	 4021176	 L mm					EUR
21-V-0	-909207	40 60 80 100	21-V-040, 21-V-060, 21-V-080, 21-V-310	21-0, 21-00, 21-01, 21-02, 21-2, 21-3, 21-4, 21-5, 21-40, 21-41, 21-42, 21-43, 21-44, 21-45, 21-46	Metall	1	136,90



Gegenstützen
ST

22

Counterstays
 Contre-appuis
 Tegensteunen
 Contraapoyos
 Controsupporti
 Podpornice

 22-1
 22-2
 22-3

 22-4
 22-5

Art.-No.		max. t			EUR
22-1	-012228	3	21-0, 21-1, 21-2, 21-3, 21-4, 21-5, 21-0-E, 21-1-E, 21-2-E, 21-3-E, 21-4-E	1	69,20
22-2	-012303	4	21-3, 21-4, 21-5, 21-6, 21-7, 21-8, 21-0-E, 21-1-E, 21-2-E, 21-3-E, 21-4-E, 21-5-E, 21-6-E, 21-7-E	1	89,30
22-3	-012488	5	21-6, 21-7, 21-8, 21-9	1	189,50
22-4	-112478	7	21-89	1	227,40
22-5	-012556	9	21-90	1	255,90

Gleithammer-Vorrichtungen
ST

22

Slide hammer devices
 Dispositifs à masse coulissante
 Glijhamer-gereedschap
 Martillos de correa
 Dispositivi battenti
 Przyrządy z młotkiem ślizgowym

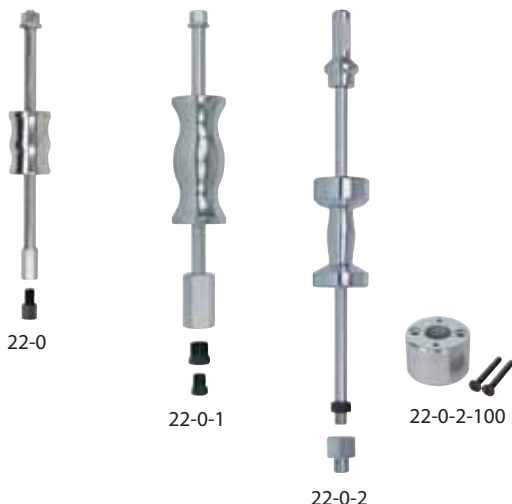





22-0

22-0-1

22-0-2

22-0-2-100



Art.-No.		 mm	 kg			EUR
22-0	-012143	150	0,5	21-0, 21-1, 21-2, 21-0-E, 21-1-E, 21-2-E, 21-3-E, 21-4-E	1	65,80
22-0-1	-555558	230	1,7	21-3, 21-4, 21-5, 21-6, 21-7, 21-8, 21-9, 21-40, 21-41, 21-42, 21-43, 21-44, 21-45, 21-46, 21-0-E, 21-1-E, 21-2-E, 21-3-E, 21-4-E, 21-5-E, 21-6-E, 21-7-E	1	143,80
22-0-2	-111204	340	5,0	21-89, 21-90	1	273,50
22-0-2-100	-111211	Zusatzgewicht	22-0-2		1	136,00

Gewindeadapter Set
ST

22-1-AS

Set of screw adapters
 Jeu d'adapteurs
 Schroefdraadadapters-set
 Juego de adaptadores
 Set di adattatori filettati
 Zestaw adapterów do gwintów



Art.-No.				EUR
22-1-AS	-339288	22-0, 22-0-1, 22-1, 22-2, 22-3	1	55,70

Gleithammersätze im Koffer

ST

KS-22



Sets of slide hammers in case
 Jeux de masses coulissantes en coffret
 Glijhamersets in koffer
 Juegos de martillo de correa en maletín
 Set di dispositivi battenti in valigetta
 Zestawy młotków ślizgowych w walizce

Art.-No.		M12	Stück pieces			EUR
KS-22-01	-924569	M3, M4, M5, M6, M8, M10 verzinkt/zinc plated: M7, M10, 15-16G	10	Kunststoff	1	147,00
KS-22-02	-951121	M6, M8x1, M10, M10x1, M12x1, M15x1,5 verzinkt/zinc plated: M7, M10, 15-16G	10	Kunststoff	1	147,00

Abziehfutter für Rillenkugellager-Innenringe

ST

23



Pulling chuck for deep groove bearing inner races
 Mandrin d'extraction pour bagues intérieures de roulement
 Klauwkoptrekker voor kogellager-binnenringen
 Mandril extractor para anillos interiores de cojinetes
 Mandrino estrattore per cuscinetti a sfera a gola profonda - anelli interni
 Głowica do ściągania do pierścieni wewnętrznych łożysk kulkowych zwykłych

Art.-No.			mm	EUR
23	-012631		5 - 32	153,60

Kugellager-Ab- und Auszieh-Sätze

ST

24



24-B



Sets of bearing pulling and extracting tools
 Jeux de arracheurs de roulement extérieur et intérieur
 Kugellager buiten- en binnentrekker-sets
 Juegos de extractores de cojinetes exteriores e interiores
 Set di dispositivi estrattori per cuscinetti a sfera
 Zestawy ściągaczy i wyciągaczy do łożysk kulkowych

Art.-No.				Stück pieces		EUR
24-A	-012716	23, 43-1, 20-1, 21-1, 21-2, 21-3, 21-4, 21-5, 21-6, 22-1, 22-2	L-Boxx	11	1	1028,70
24-B	-012891	23, 43-1, 20-1, 20-2, 21-1, 21-2, 21-3, 21-4, 21-5, 21-6, 21-7, 21-8, 22-1, 22-2	L-Boxx	14	1	1509,30
24-C	-012976	23, 43-1, 20-1, 20-2, 21-1, 21-2, 21-3, 21-4, 21-5, 21-6, 21-7, 21-8, 21-9, 22-1, 22-2, 22-4	L+Boxx	15	1	1991,30





Kugellager-Auszieh-Sätze
ST

25



25-B

Sets of bearing extracting tools
 Jeux de arracheurs de roulements intérieurs
 Kogellager binnentrekker-sets
 Juegos de extractores interiores de cojinetes
 Set di estrattori per cuscinetti a sfera
 Zestawy wyciągaczy do łożysk kulkowych





Art.-No.	 4021176	 mm			Stück pieces		EUR
25-K	-863899	6 - 19	21-00, 21-02, 21-2, 22-1	i-Boxx	4	1	314,70
25-A	-013058	12 - 46	21-1, 21-2, 21-3, 21-4, 21-5, 21-6, 22-1, 22-2	L-Boxx	8	1	632,80
25-B	-013133	12 - 70	21-1, 21-2, 21-3, 21-4, 21-5, 21-6, 21-7, 21-8, 22-1, 22-2	L-Boxx	10	1	900,90
25-C	-013218	12 - 110	21-1, 21-2, 21-3, 21-4, 21-5, 21-6, 21-7, 21-8, 22-1, 22-2, 22-4	L-Boxx	11	1	1318,40
25-D	-158803	56 - 110	21-89, 22-4	L-Boxx	2	1	618,00
25-N	-787096	11,5 - 25	21-41, 21-42, 21-43, 21-44, 21-45, 21-46, 22-1	i-Boxx	7	1	762,10

Kugellager-Schlagauszieher-Sätze
ST

26



Percussion type bearing extractor sets
 Jeux d'arracheurs de roulements intérieurs à masse coulissante
 Kogellager binnentrekkers met slagtrekker-sets
 Juegos de extractores interiores de cojinetes con martillo de correa
 Set di estrattori a percussione per cuscinetti a sfera
 Zestawy wyciągaczy udarowych do łożysk kulkowych





Art.-No.	 4021176	 mm		Stück pieces			EUR
26-A	-781629	6 - 19	21-00, 21-01, 21-02, 21-1, 21-2, KS-22-01-GH, VM12-7, V12-10	8	i-Boxx	1	346,60
26-B	-781704	12 - 40	21-1, 21-2, 21-3, 21-4, 21-5, 22-0-1, GA7-10	7	i-Boxx	1	523,20

Universal-Abziehersatz
ST

27-A

 AUTOGRIP
 TECHNOLOGY

Universal puller set
 Jeu d'extracteurs universels
 Universeel trekker-set
 Juego de extractores universales
 Set di estrattori universali
 Zestaw ściągaczy uniwersalnych

Art.-No.	 4021176	 mm		Stück pieces			EUR
27-A	-951008	8 - 48	21-01-E, 21-1-E, 21-2-E, 21-3-E, 21-4-E, 21-5-E, 22-01-G27-A, 43-001, 204-0, 69-1, 69-A2, 69-A3	21	L-Boxx	1	1030,00

2-armige Schnellspannabzieher

ST

28



2-arm quick adjusting pullers
 Extracteurs à 2 bras à serrage rapide
 2-armige snelspantrekkers
 Extractores de 2 brazos con regulación rápida
 Estrattori a 2 bracci a serraggio rapido
 2-ramienne ściągacze szybkocomujące



Art.-No.	4021176	mm	mm	mm		EUR
28-1	-850929	50 - 125	100 - 135	24	1	150,70
28-2	-851001	50 - 150	125 - 150	24	1	163,60
28-3	-851186	50 - 200	175 - 200	24	1	185,30
28-4	-851261	50 - 250	225 - 250	24	1	199,50

Gleithammersatz zum Ausziehen von Kugellagern und Passstiften

ST

28

Set of slide hammer for extracting ball bearings and dowel-pins
 Jeu de marteau à inertie pour l'arrachage de roulements à billes et de goujons d'assemblage
 Kogellager binnentrekker-set met slagtrekker en adapters
 Juego de martillo de correa para expulsar rodamientos de bolas y pasadores cilíndricos
 Set di dispositivi battenti per l'estrazione di cuscinetti a sfera e spine di registro
 Zestaw z młotkiem ślizgowym do wyciągania łożysk kulkowych i kołków pasowanych



Art.-No.	4021176	mm			Stück pieces			EUR
28-A	-507779	6 - 19	21-00, 21-01, 21-02, 21-1, 21-2, KS-22-01-GH, VM12-7, V12-10, GE3-10, GE4-10, GE5-10, GE6-10, GE8-10, GE10-10, GE12-10, GE14-10, GE16-10, GE18-10	M 3 - M18	18	i-Boxx	1	440,00
28-B	-507786	12 - 40	21-1, 21-2, 21-3, 21-4, 21-5, 22-0-1, GA12-1815, GA7-10, GE8-1815, GE10-1815, GE12-1815, GE14-1815, GE16-1815, GE18-1815, GE20-1815, GE22-1815, GE24-1815	M 8 - M24	17	i-Boxx	1	460,00

Gleithammer- und Gegenstützen-Satz zum Ausziehen von Kugellagern und Passstiften

ST

28

Set of slide hammer and counterstays for extracting ball bearings and dowel-pins
 Jeu de marteau à inertie et de contre-appuis pour l'arrachage de roulements à billes et de goujons d'assemblage
 kogellager binnentrekker-set met slagtrekker en adapters
 Juego de martillo de correa y contrasoportes para expulsar rodamientos de bolas y pasadores cilíndricos
 Set di dispositivi battenti e controsupporti per l'estrazione di cuscinetti a sfera e spine di registro
 Zestaw z młotkiem ślizgowym i wspornikami do wyciągania łożysk kulkowych i kołków pasowanych









Art.-No.	4021176	mm			Stück pieces			EUR
28-C	-466762	12 - 48	21-1, 21-2, 21-3, 21-4, 21-5, 21-6, 22-1, 22-2, KS-22-01-GH, VM12-10, VM12-1516, GE3-10, GE4-10, GE5-10, GE6-10, GE8-10, GE10-10, GE12-10, GE14-10, GE16-10, GE18-10	M 3 - M18	21	L+Boxx	1	842,70
28-D	-466779	12 - 70	21-1, 21-2, 21-3, 21-4, 21-5, 21-6, 21-7, 21-8, 22-1, 22-2, KS-22-01-GH, VM12-10, VM12-1516, GE3-10, GE4-10, GE5-10, GE6-10, GE8-10, GE10-10, GE12-10, GE14-10, GE16-10, GE18-10	M 3 - M18	23	L+Boxx	1	1113,40

Universal Trenn- und Kugellagerauszieh-Satz
ST

29-A-69



Universal set of separators and ball bearing extractors
 Jeu de séparation et d'arrachage de roulements à billes universel
 Universeel trekker-set voor uit- en inwendig gebruik
 Juego universal de expulsión de separadores y rodamientos de bolas
 Set universale di estrattori per cuscinetti a sfera e separatore
 Zestaw uniwersalnych urządzeń ściągających i rozdzielających





Art.-No.			 mm	 mm	Stück pieces			EUR
29-A-69	-101878	6004-6013 6201-6206 6300-6305	6-40	25-100	12	1	i-Boxx	345,40

Universal-Abziehersatz im TANOS-Systainer®
ST

29-B



Universal puller set in TANOS-Systainer®
 Jeu d'extracteurs universels en TANOS-Systainer®
 Universeel trekker-set in TANOS-Systainer®
 Juego de extractores en TANOS-Systainer®
 Set di estrattori universali in TANOS-Systainer®
 Zestaw ściągaczy uniwersalnych w TANOS-Systainer®

Art.-No.		 mm		Stück pieces			EUR
29-B	-111129	8 - 150	15-2, 18-2, 19-2-P, 69-1, 70-1, 70-711, 70-712, 70-713, 204-02, 482-3, 483-3	33	Tanos Systainer	1	2143,70





3-armige Universal Abzieher
ST

30



Universal 3-jaw pullers
 Extracteur universel à 3 bras
 3-armige universele trekkers
 Extractores universales de 3 brazos
 Estrattori universali a 3 bracci
 3-ramienne ściągacze uniwersalne



Art.-No.		 mm	 mm	 mm		EUR
30-1	-013393	90	100	17	1	122,30
30-10	-013621	120	100	17	1	130,70
30-2	-013478	160	150	22	1	227,40
30-20	-013706	200	150	22	1	255,90
30-3	-013546	250	200	27	1	480,30
30-30	-303005	350	200	27	1	597,00
30-4	-303302	375	200	36	1	892,70
30-40	-303319	520	200	41	1	1167,30
30-5	-303326	650	300-500	41	1	1236,00

3-armige Universal Abzieher mit verlängerten Abzughaken

ST

30



Universal 3-jaw puller with extended jaws
 Extracteur universel à 3 bras avec griffes d'extraction allongées
 3-armige universele trekkers met verlengde trekhaken
 Extractores universales de 3 brazos con ganchos de extracción prolongados
 Estrattori universali a 3 bracci con griffe allungate
 3-ramienne ściągacze uniwersalne z przedłużonymi ramionami



Art.-No.						EUR
	4021176	mm	mm	mm		
30-1-2	-730726	90	200	17	1	150,80
30-10-2	-730801	120	200	17	1	160,20
30-2-3	-730986	160	300	22	1	283,80
30-20-3	-731068	200	300	22	1	306,20
30-3-25	-901256	250	250	27	1	548,90
30-3-3	-731143	250	300	27	1	508,40
30-3-4	-731228	250	400	27	1	568,10
30-3-5	-731303	250	500	27	1	583,40

3-armige Universal Abzieher mit langer Hydraulikspindel (inklusive mechanischer Spindel)

ST

30-B



Universal 3-jaw puller with long hydraulic spindle
 Extracteur universel à 3 bras avec vis hydraulique longue
 3-armige universele trekkers met lange hydraulische spindel
 Extractores universales de 3 brazos con husillo hidráulico largo
 Estrattori universali a 3 bracci con vite idraulica lunga
 3-ramienne ściągacze uniwersalne z długim wrzecionem hydraulicznym



Art.-No.				max. t	mit with		EUR
	4021176	mm	mm				
30-2-B	-886317	160	150	7	8-01	1	457,80
30-20-B	-886348	200	150	7	8-01	1	480,10
30-3-B	-886393	250	200	10	8-02	1	713,70
30-30-B	-303104	350	200	10	8-02	1	841,70

3-armige Universal Abzieher mit verlängerten Abzughaken und langer Hydraulikspindel (inklusive mechanischer Spindel)

ST

30 B



Universal 3-jaw puller with long hydraulic spindle and extended jaws (including mechanical pressure screw)
 Extracteur universel à 3 bras avec vis hydraulique longue et griffes d'extraction allongées (y compris la vis mécanique)
 3-armige trekkers met lange hydraulische spindel en verlengde trekhaken (inclusief mechanische spindel)
 Extractores universales de 3 brazos con husillo hidráulico largo y ganchos de extracción prolongados (con husillo mecánico)
 Estrattori universali a 3 bracci con griffe allungate e vite idraulica lunga (con vite meccanico)
 3-ramienne ściągacze uniwersalne z długim wrzecionem hydr. i przedłużonymi ramionami (z wrzecionem mechanicznym)



Art.-No.				max. t	mit with		EUR
	4021176	mm	mm				
30-2-3-B	-886300	160	300	7	8-01	1	509,20
30-20-3-B	-886331	200	300	7	8-01	1	531,60
30-3-3-B	-886362	250	300	10	8-02	1	745,40
30-3-4-B	-886379	250	400	10	8-02	1	804,70
30-3-5-B	-886386	250	500	10	8-02	1	820,30

3-armiger Universal Abzieher im Set
ST

30-P3



Universal 3-arm puller-set
 Jeu d'extracteur à 3 bras
 Universeel 3-armige trekker-set
 Juego de extractor de 3 brazos
 Estrattori universali a 3 bracci in set
 3-ramienny ściągacz uniwersalny w zestawie



Art.-No.		 mm	 mm	 mm		EUR
30-10-P3	-111136	130	100 - 350	17	1	349,50
30-20-P2	-111150	200	150/300	22	1	456,90
30-3-P3	-111174	250	200/300/400	27	1	1227,00

3 Abzughaken (Satz)
ST

0-S

3 pulling arms (set)
 3 Griffes d'extraction (Jeu)
 3 trekhaken (set)
 3 Garras de extracción (Juego)
 3 griffe (set)
 3 ramiona (zestaw)



Art.-No.		 mm			EUR
1-90-S	-001413	100	30-1, 30-10	1	72,60
2-150-S	-002571	150	30-2, 30-20	1	135,60
3-200-S	-003318	200	30-3, 30-30, 30-4, 30-40	1	287,80
1-190-S	-001741	200	30-1, 30-10	1	133,80
1-250-S	-002083	250	30-1, 30-10	1	153,80
1-400-S	-975684	400	30-1, 30-10	1	195,70
2-300-S	-002816	300	30-2, 30-20	1	245,00
3-300-S	-003646	300	30-3, 30-30, 30-4, 30-40	1	350,30
3-400-S	-003981	400	30-3, 30-30, 30-4, 30-40	1	381,40
3-500-S	-004223	500	30-3, 30-30, 30-4, 30-40	1	420,70

3 Abzughakenverlängerungen (Satz)
ST

V-S

3 jaw extensions (set)
 3 rallonges de griffes (jeu)
 3 trekhaak verlengstukken (set)
 3 prolongaciones de ganchos de extracción (juego)
 3 prolunghe per griffe (set)
 3 przedłużenia do ramion (zestaw)



Art.-No.		 mm			EUR
1-V-100-S	-985065	100	30-1, 30-10	1	61,40
1-V-150-S	-985096	150	30-1, 30-10	1	81,20
2-V-150-S	-985218	150	30-2, 30-20	1	109,70

3-armige Universal Abzieher mit schmalen Abzughaken

ST

30-S



Universal 3-jaw puller with narrow jaws
 Extracteur universel à 3 bras avec griffes d'extraction minces
 3-armige universele trekkers met dunne trekhaken
 Extractores universales de 3 brazos con ganchos de extracción finos
 Estrattori universali a 3 bracci con griffe sottili
 3-ramienne ściągacze uniwersalne z wąskimi ramionami



Art.-No.						EUR
	4021176	mm	mm	mm		
30-1-S	-727771	90	100	17	1	154,40
30-10-S	-728198	120	100	17	1	163,90
30-2-S	-727856	160	150	22	1	286,90
30-20-S	-727931	200	150	22	1	309,10
30-3-S	-728013	250	200	27	1	568,30

3-armiger Universal Abzieher mit schmalen Abzughaken im Set

ST

30-SP



Universal 3-jaw puller with narrow jaws, in set
 Jeu d'extracteurs universels à 3 bras avec griffes d'extraction minces
 3-armige universele trekkers met dunne trekhaken in set
 Juego de extractor universal de 3 brazos con ganchos de extracción finos
 Estrattori universali a 3 bracci con griffe sottili in set
 3-ramienny ściągacz uniwersalny z wąskimi ramionami w zestawie



Art.-No.						EUR
	4021176	mm	mm	mm		
30-10-SP	-463839	120	100 - 350	17	1	440,90
30-20-SP	-728273	200	150 - 300	22	1	548,10
30-3-SP	-728358	250	200 - 400	27	1	1319,60

3 schmale Abzughaken (Satz)

ST

1-S

3 narrow jaws (set)
 3 griffes d'extraction minces (jeu)
 3 dunne trekhaken (set)
 3 ganchos de extracción finos (juego)
 3 griffe sottili (set)
 3 wąskie ramiona (zestaw)

1-91-S
 2-151-S
 3-201-S



1-191-S
 1-251-S
 1-401-S
 2-301-S
 3-301-S
 3-401-S
 3-501-S



Art.-No.					EUR
	4021176	mm			
1-91-S	-497834	100	30-1-S, 30-10-S	1	97,50
1-191-S	-497919	200	30-1-S, 30-10-S	1	158,70
1-251-S	-498091	250	30-1-S, 30-10-S	1	178,60
1-401-S	-985034	400	30-1-S, 30-10-S	1	228,40
2-151-S	-728686	150	30-2-S, 30-20-S	1	226,00
2-301-S	-728761	300	30-2-S, 30-20-S	1	335,50
3-201-S	-728846	200	30-3-S, 30-30, 30-4, 30-40	1	329,00
3-301-S	-728921	300	30-3-S, 30-30, 30-4, 30-40	1	389,90
3-401-S	-729003	400	30-3-S, 30-30, 30-4, 30-40	1	452,60
3-501-S	-729188	500	30-3-S, 30-30, 30-4, 30-40	1	657,20

3-armige Universal Abzieher mit extrem schmalen Abzughaken
ST

30-S-T



Universal 3-jaw puller with extremely narrow jaws
 Extracteur universel à 3 bras avec griffes d'extraction extramincées
 3-armige universele trekkers met extreem dunne trekhaken
 Extractores universales de 3 brazos con ganchos de extracción extrafinos
 Estrattori universali a 3 bracci con griffe estremamente sottili
 3-ramienne ściągacze uniwersalne z bardzo wąskimi ramionami



Art.-No.						EUR
	4021176	mm	mm	mm		
30-1-S-T	-321689	90	100	17	1	154,40
30-10-S-T	-321696	130	100	17	1	163,90

3 extrem schmale Abzughaken (Satz)
ST

4-S

3 extremely narrow jaws (set)
 3 griffes d'extraction extramincées (jeu)
 3 extreem dunne trekhaken (set)
 3 ganchos de extracción extrafinos (juego)
 3 griffe estremamente sottili (set)
 3 bardzo wąskie ramiona (zestaw)



Art.-No.					EUR
	4021176	mm			
1-94-S	-321580	100	30-1, 30-10	1	97,50
1-194-S	-321412	200	30-1, 30-10	1	158,70
1-254-S	-484520	250	30-1, 30-10	1	178,60

3-armige Universal Abzieher mit schnellverstellbaren Abzughaken
ST

30+



Universal 3-jaw puller with quick adjusting jaws
 Extracteur universel à 3 bras avec griffes d'extraction à réglage rapide
 3-armige universele trekkers met snel verstelbare trekhaken
 Extractores universales de 3 brazos con ganchos de extracción regulables rápidamente
 Estrattori universali a 3 bracci con griffe a regolazione rapida
 3-ramienne ściągacze uniwersalne z szybko przestawnymi ramionami



Art.-No.						EUR
	4021176	mm	mm	mm		
30-1+	-731488	90	100	17	1	123,50
30-10+	-731556	120	100	17	1	144,30
30-2+	-731631	160	150	22	1	259,10
30-20+	-731716	200	150	22	1	281,00
30-3+	-731891	250	200	27	1	520,90
30-30+	-303333	350	200	27	1	639,70

3-armige Universal Abzieher mit schnellverstellbaren Abzughaken und langer Hydraulikspindel (inklusive mechanischer Spindel)





ST

30+B



Universal 3-jaw puller with long hydraulic spindle and quick adjusting jaws (including mechanical pressure screw)
 Extracteur universel à 3 bras avec vis hydraulique longue et griffes d'extraction à réglage rapide (y compris la vis mécanique)
 3-armige universele trekkers met snel verstelbare trekhaken en lange hydraulische spindel (inclusief mechanische spindel)
 Extractores universales de 3 brazos con husillo hidr. largo y ganchos de extracción regulables rápidamente (con husillo mecánico)
 Estrattori universali a 3 bracci con griffe a regolazione rapida e vite idraulica lunga (con vite meccanico)
 3-ramienne ściągacze uniwersalne z długim wrzecionem hydr. i szybkoprzestawnymi ramionami (z wrzecionem mechanicznym)



Art.-No.				max. t	mit with		EUR
		mm	mm				
30-2+B	-886294	160	150	7	8-01	1	484,20
30-20+B	-886324	200	150	7	8-01	1	506,70
30-3+B	-886355	250	200	10	8-02	1	777,60
30-30+B	-303067	350	200	10	8-02	1	896,30

3 schnellverstellbare Abzughaken (Satz)





ST

2-S

3 quick adjusting jaws (set)
 3 griffes d'extraction à réglage rapide (jeu)
 3 snel verstelbare trekhaken (set)
 3 ganchos de extracción regulables rápidamente (juego)
 3 griffe a regolazione rapida (set)
 3 szybko przestawne ramiona (zestaw)

 1-92-S
 2-152-S
 3-202-S

 1-192-S
 1-252-S
 1-402-S
 2-302-S
 3-302-S
 3-402-S
 3-502-S

Art.-No.					EUR
		mm			
1-92-S	-973741	100	30-1+, 30-10+	1	76,70
1-192-S	-973635	200	30-1+, 30-10+	1	142,70
1-252-S	-973697	250	30-1+, 30-10+	1	163,10
2-152-S	-973772	150	30-2+, 30-20+	1	144,60
2-302-S	-973833	300	30-2+, 30-20+	1	255,50
3-202-S	-973895	200	30-3+, 30-30+, 30-4, 30-40	1	297,40
3-302-S	-973956	300	30-3+, 30-30+, 30-4, 30-40	1	382,70
3-402-S	-974038	400	30-3+, 30-30+, 30-4, 30-40	1	403,60
3-502-S	-974151	500	30-3+, 30-30+, 30-4, 30-40	1	438,00

3-armige Universal Abzieher mit schmalen, schnellverstellbaren Abzughaken





ST

30+S



Universal 3-jaw puller with narrow, quick adjusting jaws
 Extracteur universel à 3 bras avec griffes d'extraction minces à réglage rapide
 3-armige universele trekkers met dunne, snel verstelbare trekhaken
 Extractores universales de 3 brazos con ganchos de extracción finos regulables rápidamente
 Estrattori universali a 3 bracci con griffe sottili, a regolazione rapida
 3-ramienne ściągacze uniwersalne z wąskimi, szybkoprzestawnymi ramionami



Art.-No.						EUR
		mm	mm	mm		
30-1+S	-756894	90	100	17	1	181,00
30-10+S	-756979	120	100	17	1	195,00
30-2+S	-757051	160	150	22	1	313,50
30-20+S	-757136	200	150	22	1	335,90
30-3+S	-757211	250	200	27	1	614,00







3 schmale, schnellverstellbare Abzughaken (Satz)
ST

3-S

3 narrow, quick adjusting jaws (set)
 3 griffes d'extraction minces à réglage rapide (jeu)
 3 dunne, snel verstellbare trekhaken (set)
 3 ganchos de extracción finos regulables rápidamente (juego)
 3 griffe sottili, a regolazione rapida (set)
 3 wąskie, szybkoprzestawne ramiona (zestaw)



Art.-No.		 mm			EUR
1-93-S	-973758	100	30-1+S, 30-10+S	1	114,70
1-193-S	-973659	200	30-1+, 30-10+	1	145,20
1-253-S	-973734	250	30-1+, 30-10+	1	173,20
2-153-S	-973796	150	30-2+S, 30-20+S	1	209,90
2-303-S	-973871	300	30-2+S, 30-20+S	1	256,80
3-203-S	-973918	200	30-3+S, 30-30, 30-4, 30-40	1	352,60
3-303-S	-973994	300	30-3+S, 30-30, 30-4, 30-40	1	442,20
3-403-S	-974076	400	30-3+S, 30-30, 30-4, 30-40	1	492,40
3-503-S	-974199	500	30-3+S, 30-30, 30-4, 30-40	1	695,10





3-armige Universal Abzieher mit extrem schmalen, schnellverstellbaren Abzughaken
ST

30+ST



Universal 3-jaw puller with extremely narrow, quick adjusting jaws
 Extracteur universel à 3 bras avec griffes d'extraction extraminces à réglage rapide
 3-armige universele trekkers met extreem dunne, snel verstellbare trekhaken
 Extractores universales de 3 brazos con ganchos de extracción extrafinos regulables rápidamente
 Estrattori universali a 3 bracci con griffe estremamente sottili, a regolazione rapida
 3-ramienne ściągacze uniwersalne z bardzo wąskimi, szybkoprzestawnymi ramionami







Art.-No.		 mm	 mm	 mm		EUR
30-1+S-T	-321320	90	100	17	1	181,00
30-10+S-T	-321337	130	100	17	1	195,00

3 extrem schmale, schnellverstellbare Abzughaken (Satz)
ST

5-S

3 extremely narrow, quick adjusting jaws (set)
 3 griffes d'extraction extraminces à réglage rapide (jeu)
 3 extreem dunne, snel verstellbare trekhaken (set)
 3 ganchos de extracción extrafinos regulables rápidamente (juego)
 3 griffe sottili, a regolazione rapida (set)
 3 bardzo wąskie, szybkoprzestawne ramiona (zestaw)



Art.-No.		 mm			EUR
1-95-S	-321634	100	30-1+S, 30-10+S	1	114,70
1-195-S	-321467	200	30-1+S, 30-10+S	1	145,20
1-255-S	-321566	250	30-1+S, 30-10+S	1	173,20





Lenkradabzieher Mercedes Type

ST

31



Steering wheel pullers Mercedes Type
 Arache-volant de direction Type Mercedes
 Stuurwieltrekkers Mercedes Type
 Extractores de volantes Typo Mercedes
 Estrattore per volante modello Mercedes
 Ściągacz kierownicy, typ Mercedes

Art.-No.		 mm	 mm		EUR
31-1	-013881	30-60	22	1	211,30
31-2	-013966	80-90	22	1	343,20





Lenkradabzieher für Lenkräder mit Speichen

ST

32



Steering wheel puller for steering wheel with spokes
 Arrache-volant de direction pour volants à rayons
 Stuurwieltrekker voor stuurwielen met spaken
 Extractores de volantes para volantes con radios
 Estrattore per volante per volanti con raggi
 Ściągacz do kierownic z ramionami

Art.-No.		 mm	 mm		EUR
32-1	-014048	100	17	1	260,00
32-2	-014123	120	19	1	343,20





Lenkradabzieher für Opel

ST

33



Steering wheel pullers for Opel
 Arache-volant de direction pour Opel
 Stuurwieltrekkers voor Opel
 Extractores de volantes para Opel
 Estrattore per volante per Opel
 Ściągacz kierownicy, Opel

Art.-No.		 mm	 mm		EUR
33	-014208	50 - 150	90, 130	1	150,70

Lenkradabzieher
ST



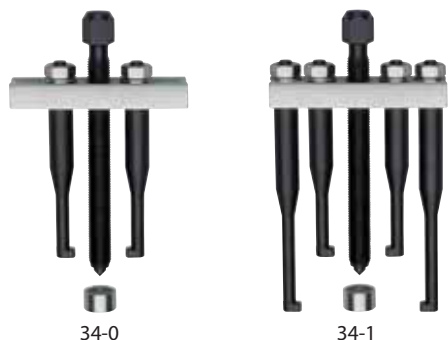

34

Steering wheel pullers
 Arache-volant de direction
 Stuurwieltrekkers
 Extractores volantes
 Estrattore per volante
 Ściągacz kierownicy



34-0

34-1







Art.-No.		Bezeichnung description	 L mm			EUR
34-0	-865879	GM 3 / Opel	35-90	-	1	112,50
34-1	-865886	Universal	35-90	34-E	1	154,80
34-E	-865893	Arme für „Frontera“	-	34-1	1	54,80

Universal-Radnabenabzieher
ST

38

Universal hub puller
 Arache-moyeux universel
 Universele wielnaaftrekkers
 Extractor universal de cubos de ruedas
 Uniwersalny ściągacz piasty koła







Art.-No.		 mm	 mm	 Stk./pcs.			EUR
38	-014383	250	27	5	-	1	255,00
38-1	-014468	Abzughaken		38		1	33,90
40-3-8	-014871	Schlagschlüssel		38, 40-3, 40-5		1	30,10

Universal-Radnabenabzieher, Schlag-/Schockmodell
ST

40

Universal hub puller, impact-/shock design
 Arache-moyeux universel, coups de marteau exécution
 Universele wielnaaftrekkers, slag-/schok-model
 Extractor universal de cubos de ruedas, modelo golpe/choque
 Estrattore universale per pneumatici
 Uniwersalny ściągacz piasty koła



Art.-No.		 mm	 Stk./pcs.			EUR
40-3	-014611	225	3	40-3-1, 40-3-8	1	273,30
40-5	-014956	225	5	40-3-1, 40-3-8	1	342,00
40-3-1	-014796	Abzughaken		40-3, 40-5	1	34,00
40-3-8	-014871	Schlagschlüssel		38, 40-3, 40-5	1	30,10

2-armige Universal Abzieher mit schwenkbaren Abzughaken
ST

41



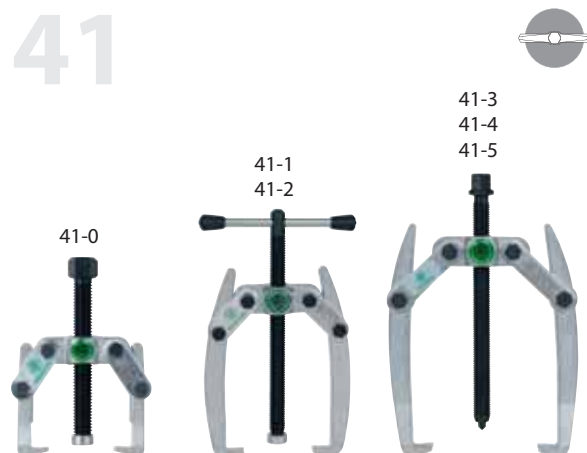

Universal 2-jaw puller with swiveling jaws
 Extracteur universel à 2 bras avec griffes d'extraction articulées
 2-armige universele trekkers met zwekbare trekhaken
 Extractores universales de 2 brazos con ganchos de extracción giratorios
 Estrattori universali a 2 bracci con griffe scorrevoli
 2-ramienne ściągacze uniwersalne z ramionami rozwieralnymi



41-0

 41-1
41-2

 41-3
41-4
41-5

Art.-No.		 mm	 mm	 mm		EUR
41-0	-362859	60	40	13	1	32,00
41-1	-015038	65	65	-	1	32,00
41-2	-015113	80	80	-	1	37,20
41-3	-787829	90	120	13	1	71,40
41-4	-836268	130	160	17	1	73,70
41-5	-836343	180	200	22	1	110,30

2-armige Universal Abzieher mit langer Hydraulikspindel (inklusive mechanischer Spindel)

ST

41-B



Universal 2-jaw puller with long hydraulic spindle (including mechanical pressure screw)
 Extracteur universel à 2 bras avec vis hydraulique longue (y compris la vis mécanique)
 2-armige universele trekkers met lange hydraulische spindel (inclusief mechanische spindel)
 Extractores universales de 2 brazos con husillo hidráulico largo (con husillo mecánico)
 Estrattori universali a 2 bracci con vite idraulica lunga (con vite meccanico)
 2-ramienne ściągacze uniwersalne z długim wrzecionem hydr. (z wrzecionem mechanicznym)



Art.-No.				max. t	mit with		EUR
		mm	mm				
41-5-B	-887345	180	200	7	8-01	1	386,00

3-armige Universal Abzieher mit schwenkbaren Abzughaken

ST

42



Universal 3-jaw puller with swiveling jaws
 Extracteur universel à 3 bras avec griffes d'extraction articulées
 3-armige universele trekkers met zwekbare trekhaken
 Extractores universales de 3 brazos con ganchos de extracción giratorios
 Estrattori universali a 3 bracci con griffe scorrevoli
 3-ramienne ściągacze uniwersalne z ramionami rozwieralnymi



Art.-No.						EUR
		mm	mm	mm		
42-0	-362026	60	40	13	1	42,50
42-1	-015298	65	65	-	1	42,50
42-2	-015373	80	80	-	1	51,20
42-3	-787904	90	120	13	1	97,50
42-4	-836428	130	160	17	1	99,20
42-5	-836596	180	200	22	1	147,10

3-armige Abzieher mit langer Hydraulikspindel (inklusive mechanischer Spindel)

ST

42-B



3-jaw puller with long hydraulic spindle (including mechanical pressure screw)
 Extracteur à 3 bras avec vis hydraulique longue (y compris la vis mécanique)
 3-armige trekkers met lange hydraulische spindel (inclusief mechanische spindel)
 Extractores de 3 brazos con husillo hidráulico largo (con husillo mecánico)
 Estrattori universali a 3 bracci con vite idraulica lunga (con vite meccanico)
 3-ramienne ściągacze z długim wrzecionem hydraulicznym (z wrzecionem mechanicznym)



Art.-No.				max. t	mit with		EUR
		mm	mm				
42-5-B	-887352	180	200	7	8-01	1	421,10



2-armiger Kleinteilabzieher mit selbstzentrierenden Abzughaken
ST

43



2-jaw small part puller with self-centering jaws
 Extracteur de petites pièces à 2 bras avec griffes d'extraction autocentreuses
 2-armige trekker voor kleine delen met zelfcenterende trekhaken
 Extractor para piezas pequeñas de 2 brazos con ganchos de extracción autocentrantes
 Estrattore per minuteria a 2 bracci con griffe autocentranti
 2-ramienny ściągacz do małych elementów z samocentrującymi ramionami



Art.-No.								EUR
		mm	mm	mm	mm	mm		
43-001	-913518	60	50	1,5	10	4,5	1	72,80

3-armiger Kleinteilabzieher mit selbstzentrierenden Abzughaken
ST

43-011



3-jaw small part puller with self-centering jaws
 Extracteur de petites pièces à 3 bras avec griffes d'extraction autocentreuses
 3-armige trekker voor kleine delen met zelfcenterende trekhaken
 Extractor para piezas pequeñas de 3 brazos con ganchos de extracción autocentrantes
 Estrattore per minuteria a 3 bracci con griffe autocentranti
 3-ramienny ściągacz do małych elementów z samocentrującymi ramionami



Art.-No.								EUR
		mm	mm	mm	mm	mm		
43-011	-913501	60	50	1,5	10	4,5	1	92,60

2-armige Universal Abzieher mit selbstzentrierenden Abzughaken
ST

43



Universal 2-jaw puller with self-centering jaws
 Extracteur universel à 2 bras avec griffes d'extraction autocentreuses
 2-armige universele trekkers met zelfcenterende trekhaken
 Extractores universales de 2 brazos con ganchos de extracción autocentrantes
 Estrattori universali a 2 bracci con griffe autocentranti
 2-ramienne ściągacze uniwersalne z samocentrującymi ramionami



Art.-No.					EUR
		mm	mm		
43-1	-015458	60	50	1	43,80
43-2	-015861	70	70	1	44,90
43-3	-015946	80	80	1	46,00

3-armige Universal Abzieher mit selbstzentrierenden Abzughaken

ST

43



Universal 3-jaw puller with self-centering jaws
 Extracteur universel à 3 bras avec griffes d'extraction autocentreuses
 3-armige universele trekkers met zelfcenterende trekhaken
 Extractores universales de 3 brazos con ganchos de extracción autocentrantes
 Estrattori universali a 3 bracci con griffe autocentranti
 3-ramienne ściągacze uniwersalne z samocentrującymi ramionami



Art.-No.		 mm	 mm		EUR
43-11	-015526	60	50	1	55,50
43-12	-015601	70	70	1	56,30
43-13	-015786	80	80	1	59,80

2-armige Universal Abzieher mit selbstzentrierenden Abzughaken

ST

44



Universal 2-jaw puller with self-centering jaws
 Extracteur universel à 2 bras avec griffes d'extraction autocentreuses
 2-armige universele trekkers met zelfcenterende trekhaken
 Extractores universales de 2 brazos con ganchos de extracción autocentrantes
 Estrattori universali a 2 bracci con griffe autocentranti
 2-ramienne ściągacze uniwersalne z samocentrującymi ramionami



Art.-No.		 mm	 mm		EUR
44-1	-016028	100	100	1	52,00
44-2	-016103	120	120	1	81,50
44-3	-016288	160	160	1	126,10
44-4	-016363	250	200	1	175,00
44-5	-815133	300	250	1	230,00
44-6	-815218	375	275	1	368,70

3-armige Universal Abzieher mit selbstzentrierenden Abzughaken

ST

45



Universal 3-jaw puller with self-centering jaws
 Extracteur universel à 3 bras avec griffes d'extraction autocentreuses
 3-armige universele trekkers met zelfcenterende trekhaken
 Extractores universales de 3 brazos con ganchos de extracción autocentrantes
 Estrattori universali a 3 bracci con griffe autocentranti
 3-ramienne ściągacze uniwersalne z samocentrującymi ramionami



Art.-No.		 mm	 mm		EUR
45-1	-016448	100	100	1	79,00
45-2	-016516	120	120	1	117,80
45-3	-016691	160	160	1	176,00
45-4	-016776	250	200	1	248,90
45-5	-815393	300	250	1	309,70
45-6	-815478	375	275	1	538,80
45-7	-821646	600	350	1	744,10

2-armige Universal Abzieher mit schwenkbaren Abzughaken
ST

46



Universal 2-jaw puller with swiveling jaws
 Extracteur universel à 2 bras avec griffes d'extraction articulées
 2-armige universele trekkers met zwekbare trekhaken
 Extractores universales de 2 brazos con ganchos de extracción giratorios
 Estrattori universali a 2 bracci con griffe scorrevoli
 2-ramienne ściągacze uniwersalne z ramionami rozwieralnymi



Art.-No.								EUR
		mm	mm	mm	mm			
46-1-A	-016936	300	300	36	-	-	1	342,90
46-2-A	-017193	500	450	36	-	-	1	414,10
46-47-T	-464737	Traverse			-	46-1-A, 46-1-B, 46-2-A, 46-2-B, 47-1-A, 47-1-B, 47-2-A, 47-2-B	1	136,10
46-300	-017438	Abzughaken komplett			300		1	122,70
46-450	-170461	Abzughaken komplett			450		1	122,40

2-armige Universal Abzieher mit schwenkbaren Abzughaken und langer Hydraulikspindel (inklusive mechanischer Spindel)
ST

46



Universal 2-jaw puller with long hydraulic spindle and swiveling jaws (including mechanical pressure screw)
 Extracteur universel à 2 bras avec vis hydraulique longue et griffes d'extraction articulées (y compris la vis mécanique)
 2-armige universele trekkers met lange hydraulische spindel en zwekbare trekhaken (inclusief mechanische spindel)
 Extractores universales de 2 brazos con husillo hidráulico largo y ganchos de extracción giratorios (con husillo mecánico)
 Estrattori universali a 2 bracci con griffe scorrevoli e vite idraulica lunga (con vite meccanico)
 2-ramienne ściągacze uniwersalne z długim wrzecionem hydr. i ramionami rozwieralnymi (z wrzecionem mechanicznym)



Art.-No.				max. t	mit with		EUR
		mm	mm				
46-1-B	-017018	300	300	15	8-1-F	1	940,70
46-2-B	-017278	500	450	15	8-1-F	1	1011,90

3-armige Universal Abzieher mit schwenkbaren Abzughaken
ST

47



Universal 3-jaw puller with swiveling jaws
 Extracteur universel à 3 bras avec griffes d'extraction articulées
 3-armige universele trekkers met zwekbare trekhaken
 Extractores universales de 3 brazos con ganchos de extracción giratorios
 Estrattori universali a 3 bracci con griffe scorrevoli
 3-ramienne ściągacze uniwersalne z ramionami rozwieralnymi



Art.-No.						EUR
		mm	mm	mm		
47-1-A	-017681	300	300	36	1	411,90
47-2-A	-017841	500	450	36	1	504,00





3-armige Universal Abzieher mit schwenkbaren Abzughaken und langer Hydraulikspindel (inklusive mechanischer Spindel)

ST

47

hydraulic
TECHNOLOGY

Universal 3-jaw puller with long hydraulic spindle and swiveling jaws (including mechanical pressure screw)
 Extracteur universel à 3 bras avec vis hydraulique longue et griffes d'extraction articulées (y compris la vis mécanique)
 3-armige universele trekkers met lange hydraulische spindel en zwenkbare trekhaken (inclusief mechanische spindel)
 Extractores universales de 3 brazos con husillo hidráulico largo y ganchos de extracción giratorios (con husillo mecánico)
 Estrattori universali a 3 bracci con griffe scorrevoli e vite idraulica lunga (con vite meccanico)
 3-ramienne ściągacze uniwersalne z długim wrzecionem hydr. i ramionami rozwiewalnymi (z wrzecionem mechanicznym)

Art.-No.		 mm	 mm	max. t	mit with		EUR
47-1-B	-017766	300	300	15	8-1-F	1	1009,70
47-2-B	-017926	500	450	15	8-1-F	1	1101,80





Batterieklemmen-Abzieher

ST

48

AUTOGRIP
TECHNOLOGY

Battery terminal puller
 Arrache-cosses de batteries
 Accupoolklemtrekkers
 Extractor de bornes batería
 Estrattore per morsetti di batterie
 Ściągacz do zacisków akumulatorów

Art.-No.		 mm	 mm		EUR
48	-170539	60	40	1	53,70



Schraubenausdreher mit fein gerillter, deutscher Form

ST

49



Bolt extractors german, shape with narrow flutes
 Extracteurs de vis cassés. modèle allemand, à rainures fines
 Boutuitdraaiers, Duitse uitvoering, fijn gegroefd
 Extractores de tornillos, ejecución alemana, estriado fino
 Estrattori per viti modello tedesco, filetto sottile
 Wykrętak o drobno żłobkowym, niemieckim kształcie





Art.-No.		 mm		EUR
49-1	-018008	3 - 6	5	4,10
49-2	-018183	6 - 8	5	4,10
49-3	-018268	8 - 11	5	4,10
49-4	-018343	11 - 14	5	4,90
49-5	-018428	14 - 18	5	5,80
49-6	-018596	18 - 24	5	7,90
49-7	-018671	24 - 33	5	12,40
49-8	-018756	33 - 45	5	17,80
49-9	-018831	45 - 52	5	38,40
49-10	-239809	52 - 64	5	71,90

Schraubenausdreher-Satz mit fein gerillter, deutscher Form
ST

49



Bolt extractor sets
 Jeux d'extracteurs de vis cassés
 Boutuitdraaiers-sets
 Juegos de extractores de tornillos
 Set di estrattori per viti modello tedesco, filetto sottile
 Zestawy wykręteków



Art.-No.		 mm	Stück pieces			EUR
49-A	-018916	3 - 18	5	Kunststoff	1	26,10
49-B	-019098	3 - 24	6	Kunststoff	1	31,60
49-C	-019173	3 - 45	8	Kunststoff	1	63,10

Schraubenausdreher mit breit gerillter, amerikanischer Form
ST

49



Bolt extractors, american shape with broad flutes
 Extracteurs de vis cassés, Modèle américain, à rainures larges
 Boutuitdraaiers, Amerikaanse uitvoering, breed gegroefd
 Extractores de tornillos, ejecución americana, estriado ancho
 Estrattori per viti modello americano, filetto largo
 Wykrętek o szeroko żłobkowym, amerykańskim kształcie



Art.-No.		 mm		EUR
49-01	-490569	3 - 6	5	9,90
49-02	-490644	6 - 8	5	12,10
49-03	-490729	8 - 11	5	12,10
49-04	-490804	11 - 14	5	14,40
49-05	-490989	14 - 18	5	15,10
49-06	-491061	18 - 24	5	18,20

Schraubenausdreher-Satz mit breit gerillter, amerikanischer Form
ST

49-0-S



Bolt extractor set, american shape with broad flutes
 Jeu d'extracteurs de vis cassés, modèle américain, à rainures larges
 Boutuitdraaiers-set, Amerikaanse uitvoering, breed gegroefd
 Juego de extractores de tornillos, ejecución americana, estriado ancho
 Set di estrattori per viti modello americano, filetto largo
 Zestaw wykręteków o szeroko żłobkowym, amerykańskim kształcie



Art.-No.		 mm	Stück pieces		EUR
49-0-S	-491146	3 - 24	6	1	82,80

Schraubenausdreher „Super Traction“
ST

49-T



Bolt extractors „Super Traction“
 Extracteurs de vis cassés „Super Traction“
 Boutuitdraaiers „Super Traction“
 Extractores de tornillos „Super Traction“
 Estrattori per viti, modello „Super Traction“
 Wykrętek „Super Traction“

Art.-No.		 mm		EUR
49-T-1	-758461	4 - 5	5	5,80
49-T-2	-758539	5 - 7	5	5,90
49-T-3	-758614	8 - 12	5	7,30
49-T-4	-758799	12 - 14	1	8,70
49-T-5	-758874	16 - 20	1	11,50





Schraubenausdreher-Satz „Super Traction“

ST

49-T-A



Bolt extractor set „Super Traction“
 Jeu d'extracteurs de vis cassés „Super Traction“
 Boutuitdraaiers-set „Super Traction“
 Juego de extractores de tornillos „Super Traction“
 Set di estrattori per viti modello „Super Traction“
 Zestaw wykrętaaków „Super Traction“

Art.-No.		 mm	Stück pieces			EUR
49-T-A	-758959	4 - 20	5	Kunststoff	1	41,90





Schraubenausdreher-Satz mit Bohrern und Bohrbüchse

ST

49-U-B



Bolt extractor set
 Jeu d'extracteurs de vis cassés
 Boutuitdraaiers set
 Juego de extractores de tornillos
 Set di estrattori di viti con con punte in acciaio e boccole di foratura.
 Zestaw wykrętaaków do śrub

Art.-No.		 mm		Stück pieces		EUR
49-U-B	-799136	M5 - M16	L-Boxx MINI	25	1	150,50





Schraubenausdreher mit Bohrern und Bohrbüchse

ST

49-U



Bolt extractors with drills and drill-guide
 Extracteurs de vis cassés avec forets et canon de perçage
 Buituitdraaiers met boren en boorgeleidingsbus
 Extractor de tornillos con brocas y cacillo de talaradrar
 Estrattore per viti con perforatori e maschere di foratura
 Wykrętaak z wiertłami i tulejką wiertarską





Art.-No.		 mm	 mm		EUR
49-U-11	-799549	M5 - M7	3,2	1	21,80
49-U-12	-799624	M8 - M9	4,8	1	29,30
49-U-13	-799709	M10	6,4	1	34,70
49-U-14	-799884	M12	8,0	1	42,00
49-U-15	-799969	M14 - M16	8,7	1	54,30

Stehbolzen-Ausdreher mit Innenverzahnung
ST

50



Stud pullers with internal serration
 Dégoujonneuses avec denture intérieure
 Tapeind-uitdraaiers met binnenvertanding
 Extractores de espárragos con dientes interiores
 Svitatori per prigionieri con dentatura interna
 Nasadka do wykręcania śrub kołkowych z uzębieniem wewnętrznym





Art.-No.		 mm	 mm		EUR
50-1	-019258	5 - 10	17	1	58,90
50-2	-019333	8 - 19	27	1	74,30
50-3	-019418	18 - 25	36	1	89,80

Stehbolzen-Ausdreher mit Innenverzahnung
ST

51



Stud pullers with internal serration
 Dégoujonneuses avec denture intérieure
 Tapeind-uitdraaiers met binnenvertanding
 Extractores de espárragos con dientes interiores
 Svitatori per prigionieri con dentatura interna
 Nasadka do wykręcania śrub kołkowych z uzębieniem wewnętrznym





Art.-No.		 mm	 mm		EUR
51-1	-019586	5 - 10	19	1	50,30
51-2	-019661	8 - 19	19	1	67,20
51-3	-019746	18 - 25	19	1	82,00

Stehbolzen-Ausdreher mit großem Spannbereich
ST

52



Stud puller with extra wide working range
 Dégoujonneuse avec capacité extra grande
 Tapeind-uitdraaiers met extra groot spanbereik
 Extractores de espárragos con dientes interiores
 Svitatore prigionieri con grande campo di serraggio
 Nasadka do wykręcania śrub kołkowych o dużym zakresie mocowania

Art.-No.		 mm	 mm		EUR
52	-019821	5 - 19	19	1	108,90





Stehbolzen-Ausdreher für enge Platzverhältnisse

ST

53



Stud pullers for confined spaces
 Dégoujonneuses pour endroits exigues
 Tapeind-uitdraaiers voor nauwe tussenruimtes
 Extractores de espárragos para intersticios angostos
 Svitatore prigioniere per spazi ristretti
 Nasadka do wykręcania śrub kołkowych do niewielkich przestrzeni

Art.-No.	 4021176	 mm	 mm		EUR
53-5	-137860	5	21	1	49,40
53-6	-342318	6	21	1	49,40
53-7	-866234	7	21	1	49,40
53-8	-342493	8	21	1	49,40
53-10	-342561	10	21	1	49,40
53-12	-342646	12	21	1	53,60
53-14	-984563	14	27	1	64,60
53-16	-388774	16	27	1	64,60
53-18	-137846	18	36	1	370,80
53-20	-745591	20	36	1	421,60
53-22	-971082	22	36	1	439,50
53-24	-966774	24	36	1	453,20
53-30	-966781	30	46	1	494,40





Stehbolzen-Ausdreh-Set für enge Platzverhältnisse

ST

53



Stud pullers set for confined spaces
 Jeu de dégonjonnes pour endroits exigues
 Tapeind-uitdraaiers set voor nauwe tussenruimtes
 Juego de extractores de espárragos para intersticios angostos
 Set di svitatori prigioniere per spazi ristretti
 Zestaw nasadek do wykręcania śrub kołkowych do niewielkich przestrzeni

Art.-No.	 4021176	 mm	Stück pieces			EUR
53	-342233	6, 8, 10, 12	4	Kunststoff	1	200,50







Zweischneidige, mechanische Mutternsprenger

ST

54



Double-edged, mechanic nut splitters
 Casse-écrous mécaniques à deux tranchants
 Dubbelsnijdende mechanische moerensplijter
 Tronzatuercas mecánicas de dos filos
 Spaccadadi meccanico, a due taglienti
 Dwuostrzowy, mechaniczny przecinak do nakrętek







Art.-No.	 4021176	 mm	 inch	 M			EUR
54-2	-170614	10-27	$\frac{13}{32} - \frac{1}{16}$	6-18	54-2-M	1	92,40
54-3	-170799	17-36	$\frac{11}{16} - \frac{1}{16}$	12-24	54-3-M	1	120,30
54-2-M	-253041	Ersatzmeißel			54-2	1	43,00
54-3-M	-253126	Ersatzmeißel			54-3	1	43,00

Einschneidige, mechanische Mutternsprenger
ST

55









Single-edged, mechanical nut splitters
 Casse-écrous mécanique à un tranchant
 Mechanische moerensplijters met een mes
 Tronzatuercas mecánico de un filo
 Spaccadadi meccanici a un tagliente
 Jednoostrzowy, mechaniczny rozwiertak do nakrętek

Art.-No.		 mm	 inch	 M			EUR
55-0	-019906	4-10	$\frac{5}{32} - \frac{13}{32}$	M2-M6	55-0-M	1	63,10
55-1	-020063	10-18	$\frac{7}{16} - \frac{11}{16}$	M6-M12	55-1-M	1	76,90
55-2	-020148	19-27	$\frac{3}{4} - 1 \frac{1}{16}$	M12-M18	55-2-M	1	82,40
55-3	-020223	27-36	$1 \frac{1}{8} - 1 \frac{7}{16}$	M18-M24	55-3-M	1	107,10
55-4	-020308	32-50	$1 \frac{5}{16} - 2$	M22-M33	55-4-M	1	357,10
55-0-M	-252549	Ersatzmeißel			55-0	1	34,00
55-1-M	-252624	Ersatzmeißel			55-1	1	34,00
55-2-M	-252709	Ersatzmeißel			55-2	1	43,00
55-3-M	-252884	Ersatzmeißel			55-3	1	43,00
55-4-M	-252969	Ersatzmeißel			55-4	1	43,00

Einschneidige, fetthydraulische Mutternsprenger
ST

56

Single-edged, grease hydraulic nut splitters
 Casse-écrous oléohydrauliques à un tranchant
 Enkelsnijdende vethydraulische moerensplijter
 Tronzatuercas oleohidráulicos de un filo
 Spaccadadi oleoidraulico, a un tagliente
 Jednoostrzowe, hydrauliczne przecinaki do nakrętek

Art.-No.		Edelstahl	 mm	 inch	 M			EUR
56-1	-020483	-	7-24	$\frac{9}{32} - \frac{15}{16}$	M4-M14	56-1-M	1	200,50
56-2	-020551	-	22-36	$\frac{7}{8} - 1 \frac{7}{16}$	M14-M24	56-2-M	1	377,80
56-3	-111501	bis Güte 8 bis Güte 10	27-36 27-46	$1 \frac{1}{8} - 1 \frac{13}{16}$ $1 \frac{1}{8} - 1 \frac{7}{16}$	M18-M24 M18-M30	56-3-M	1	552,10
56-1-M	-253201	Ersatzmeißel			56-1	1	34,00	
56-2-M	-253386	Ersatzmeißel			56-2	1	43,00	
56-3-M	-111518	Ersatzmeißel			56-3	1	100,00	



58



KUKKO Thread Repair System in the TANOS® - Systainer
 Système KUKKO Thread Repair dans le Systainer TANOS®
 KUKKO schroefdraad reparatie systeem in TANOS®-Systainer
 Sistema Thread Repair de KUKKO en TANOS®-Systainer
 Sistema di riparazione fili KUKKO in TANOS® - Systainer
 System naprawczy KUKKO Thread Repair System w TANOS® - Systainer





Art.-No.							EUR
	40211761		mm	mm	Stk./pcs.		
58-M03	-117558	M3 M3	0,5 0,5	4,3 6,0	5 5	1	166,40
58-M04	-117602	M4 M4	0,7 0,7	6,0 8,0	5 5	1	166,40
58-M05	-117664	M5 M5	0,8 0,8	7,6 10,0	5 5	1	166,40
58-M06	-117725	M6 M6	1,0 1,0	9,4 12,0	5 5	1	166,40
58-M07	-695001	M7 M7	1,0 1,0	10,0 14,0	5 5	1	204,70
58-M08	-689246	M8	1,0	11,7	10	1	204,70
58-M08125	-117848	M8 M8	1,25 1,25	11,7 16,2	5 5	1	204,70
58-M10	-689376	M10	1,0	15,0	10	1	204,70
58-M10125	-117923	M10 M10	1,25 1,5	15,0 20,0	5 5	1	204,70
58-M10150	-689383	M10 M10	1,5 1,5	14,0 20,0	5 5	1	204,70
58-M11125	-118036	M11	1,25	22,0	10	1	213,30
58-M11150	-689611	M11 M11	1,50 1,50	16,0 22,0	5 5	1	213,30
58-M12125	-689758	M12 M12	1,25 1,25	15,0 24,0	5 5	1	213,30
58-M12150	-689765	M12 M12	1,5 1,5	16,2 24,0	5 5	1	213,30
58-M12175	-118128	M12 M12	1,75 1,75	16,2 24,0	5 5	1	213,30
58-M14150	-690013	M14 M14	1,5 1,5	16,0 26,0	5 5	1	281,40
58-M16150	-690112	M16 M16	1,5 1,5	12,7 24,0	5 5	1	281,40
58-M16200	-690129	M16 M16	2,0 1,5	24,0 32,0	5 5	1	375,20
58-M18150	-690310	M18 M18	1,5 1,5	18,3 27,0	5 5	1	392,30
58-UNC10	-690419	10" 10"	24 Gang 24 Gang	0,30 0,37	5 5	1	166,40
58-UNC12	-690518	1/2" 1/2"	13 Gang 13 Gang	0,65 1,00	5 5	1	281,40
58-UNC14	-690617	1/4" 1/4"	20 Gang 20 Gang	0,38 0,50	5 5	1	204,70
58-UNC38	-690716	3/8" 3/8"	16 Gang 16 Gang	0,52 0,75	5 5	1	204,70
58-UNC58	-690921	5/8" 5/8"	11 Gang 11 Gang	0,85 1,25	5 5	1	417,90
58-UNC516	-690815	5/16" 5/16"	18 Gang 18 Gang	0,45 0,62	5 5	1	204,70
58-UNC716	-691027	7/16" 7/16"	14 Gang 14 Gang	0,60 0,87	5 5	1	281,40
58-UNC916	-695025	9/16" 9/16"	12 Gang 12 Gang	0,75 1,12	5 5	1	392,30

Kettenlöser- und Verniet-Werkzeug-Satz
ST

59



Chain splitting and riveting tool
 Outil de détachement de la chaîne et de rivetage
 Ketting de- en montage gereedschap set
 Juego de herramientas remachadoras y para soltar la cadena
 Set di strumenti per smagliatura e ribaditura catene
 Zestaw narzędzi do rozłączania łańcuchów i nitowania





Art.-No.		 mm		Stück pieces			EUR
KS-59-1/14	-800207	3,28 - 5,72	59-1, 59-1-1, 59-1-2, 58-1	14	i-Boxx	1	423,00
59-1	-800214	-	Grundgerät			1	220,00
59-1-1	-800221	3,28 - 4,45	Ersatzteilsatz			1	43,00
59-1-2	-800238	5,08 - 5,72	Ersatzteilsatz			1	70,00
58-1	-800245	-	Montagespanner			1	100,00

Innenfederspanner-Satz für Daimler
ST

KS-63-1/5



Spring compressors set Daimler
 Jeu de compresseurs de ressorts Daimler
 Veerspanner-set Daimler
 Juego de compresores de muelles Daimler
 Set pressori interni per molle per Daimler
 Zestaw wewnętrznych napinaczy sprężyn, Daimler



Art.-No.					EUR
KS-63-1/5	-800009	63-1, 63-1-A, 63-1-B	1	Kunststoff	1091,30

Federhalter
ST

63



Jaws
 Griffes
 Veerspanners
 Garras
 Supporto molla
 Uchwyt sprężyny





Art.-No.		 Stk./pcs.	Bezeichnung description		EUR
63-1	-800016	-	Grundgerät	1	406,20
63-1-A	-800023	2	kleine Federhalterplatten	1	198,90
63-1-B	-800030	2	große Federhalterplatten	1	198,90

Federspanner „All in One“
ST

64



Spring compressors „All in one“
 Compresseurs de ressorts „All in one“
 Veerspanners „All in one“
 Compresores de muelles „All in one“
 Pressori „All in one“
 Napinacz sprężyn „All in One“

Art.-No.		 mm	 mm	max. t		EUR
64-1	-987281	80 - 200	40 - 396	2,5	1	962,30



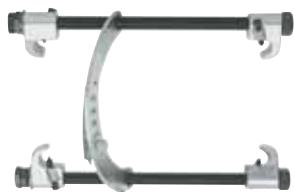

Federspanner „Universal“

ST

65



Spring compressor „Universal“
Compresseur de ressorts „Universal“
Veerspanners „Universal“
Compresor de muelles „Universal“
Pressori „Universal“
Napinacz sprężyn „Universal“

Art.-No.		 mm	 mm	max. t		EUR
65-0	-020636	110 - 180	100 - 200	2	1	185,30
65-1	-020711	110 - 180	100 - 300	2	1	204,30
65-2	-020896	110 - 180	100 - 400	2	1	227,70





KFZ Universal Werkstattgarnitur

ST

K-65-A



Set of universal automotive repair shop tools
Jeu universel pour ateliers automobiles
Universeel werkplaatsset voor personenwagens
Juego universal para taller de automóviles
Dotazione d'officina universale per automobili
Uniwersalny zestaw warsztatowy do samochodów

Art.-No.					EUR
K-65-A	-412851	65-1, 129-0, 135-1, 210-1, 230, 123-2	Metall	1	1252,10



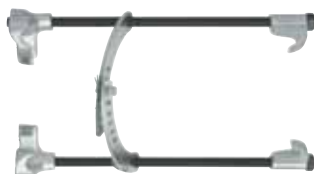

Federspanner „MacPherson“

ST

66



Spring compressor „MacPherson“
Compresseur de ressorts „MacPherson“
Veerspanners „MacPherson“
Compresor de muelles „MacPherson“
Pressori „MacPherson“
Napinacz sprężyn „MacPherson“

Art.-No.		 mm	 mm	max. t		EUR
66-1	-020971	110 - 180	100 - 250	2,5	1	221,80
66-2	-170201	110 - 180	100 - 400	2,5	1	234,30
66-3	-170386	110 - 180	100 - 400	2,5	1	278,20





Federspanner-Satz

ST

67



Set of spring compressors
Jeu de compresseurs de ressorts
Veesspanner-set
Juego de compresores de muelles
Set di pressori
Zestaw napinaczy sprężyn





Art.-No.		 mm	 Stk./pcs.	max. t			EUR
67-2	-924286	80 - 195	2+2	2,25	67-01, 67-02	1	831,50

Federhalter
ST

67



Jaws
Griffes
Veerspanners
Garras
Supporto molla
Uchwyt sprężyny

Art.-No.		 mm	 x Stk./pcs.		EUR
67-01	-076527	80 - 145	1	1	106,60
67-02	-076534	145 - 195	1	1	120,80
67-03	-076541	140 - 170	1	1	194,80
67-04	-076558	180 - 230	1	1	164,90
67-05	-076565	80 - 120	1	1	126,50
67-06	-076572	80 - 145	1	1	143,50
67-07	-099465	BMW E39/46; Renault Megane II; Toyota Avensis	1	1	282,90
67-08	-924514	Mercedes C-Klasse Type 203	1	1	217,50
67-09	-924521	Mercedes E-Klasse Type 211, Renault Megane II	1	1	217,50
67-10	-924538	Peugot Break; Citroen C15	2	1	261,50
67-12	-924552	Chrysler Grand Voyager	1	1	236,00





Kugellager-Abzieh-Sätze „Universal“
ST

69

 69-A
69-B

69-C

Ball bearing extractor sets „Universal“
Jeux d'arrache-roulements à billes „Universal“
Kogellagertrekker set „Universal“
Juegos de extractores de cojinetes de bolas „Universal“
Set di estrattori per cuscinetti a sfera „Universal“
Zestawy ściągaczy do łożysk kulkowych „Universal“





Art.-No.			Stück pieces			EUR
69-A	-781391	6004-6013; 6201-6206; 6300-6305	7	1	L-Boxx MINI	282,90
69-B	-781476	6011-6020; 6206-6212; 6305-6309; 6403-6407	7	1	L-Boxx MINI	384,50
69-C	-781544	6021-6032; 6213-6230; 6310-6321; 6406-6417	10	1	L-Boxx	821,20

Kugellager-Abzieh-Sätze für Rillenkugellager
ST

70



Ball bearing extractor sets for deep-groove ball bearings
Jeux d'arrache-roulements pour roulements rainurés à billes
Kogellagertrekker sets voor groefkogellagers
Juegos de extracción para cojinetes de bolas ranurados
Set di estrattori per cuscinetti a sfera a gola profonda
Zestawy ściągaczy do łożysk kulkowych zwykłych

Art.-No.			Stück pieces			EUR
70-K	-786754	6000-6013; 6200-6207; 6300-6306	35	1	L-Boxx	821,20
70-A	-022128	6000-6013; 6200-6212; 6300-6311; 6403-6408	57	1	L-Boxx	1233,20
70-B	-320866	6014-6021; 6213-6222; 6312-6317; 6409-6415	47	1	L-Boxx	2304,40

INFOBOX: Kugellager Ausziehen

Kugellager, die gleichzeitig in einem Gehäuse und auf einer Welle sitzen.

Das Lager muss nach dem Ausbau ersetzt werden!

Das Lager kann nach dem Ausbau wieder verwendet werden!

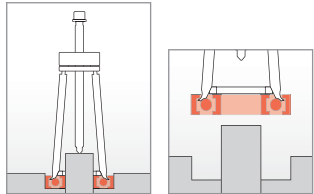
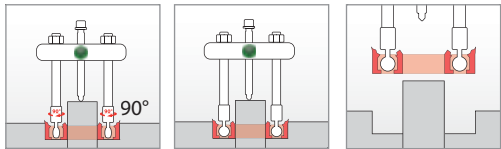
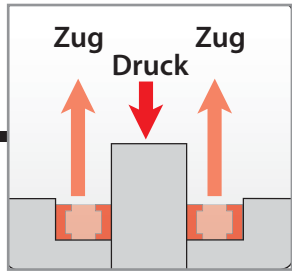

Neues Lager!

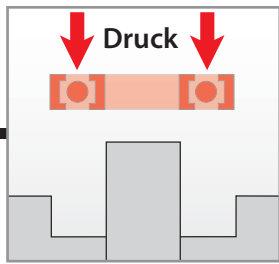

Neues oder gebrauchtes Lager

Werkstattmodell stahl
Stahl, schwere Ausführung

71

kg
18,6

Werkstattmodell stahl
kurze, schwere Ausführung

71-K

kg
8,6

Außenmontagemodell
leichte Ausführung

71-L

kg
4,6



TIPP! Für einen besonders festen Sitz des Kugellagers auf der Welle empfehlen wir unser induktives Kugellager-Anwärmgerät T-AW. Das Kugellager wird erhitzt, auf die Welle geschlagen und presst sich mit dem Erkalten sehr fest an die Welle.





Kugellager-Abzieher und Abzughakensätze
ST

70



Ball bearing extractors and pulling arm sets
 Arrache roulements et jeux de griffes
 Kogellagertrekkers en trekhaken-sets
 Extractores de cojinetes y juegos de garras
 Set di estrattori per cuscinetti a sfera e set di griffe
 Ściągacz do łożysk kulkowych i zestawy ramion





Art.-No.			EUR
70-1	-021138	70-711, 70-713, 70-712	54,90
70-2	-021213	70-721, 70-722	82,40
70-3	-021398	70-731, 70-732	164,80
70-4	-316418	70-4730, 70-4731, 70-4733, 70-4734	343,30

Abzughakensätze
ST

70



Pulling arm sets
 Jeux de griffes
 Trekhaken-sets
 Juegos de garras
 Set di griffe
 Zestawy ramion ściągających





Art.-No.						EUR
70-711	-021473	6000-6003 6200	4	70-1	1	109,90
70-712	-021541	6004-6006 6201-6203 6300	6	70-1	1	123,60
70-713	-021626	6204-6205 6301-6303	5	70-1	1	123,60
70-721	-021701	6007-6013	1	70-2	1	123,60
70-722	-021886	6011-6012 6206-6207 6304-6306	4	70-2	1	123,60
70-731	-021961	6208-6210 6307 6403 6407	6	70-3	1	192,30
70-732	-022043	6211-6212 6308-6311 6404-6408	9	70-3	1	192,30
70-4731	-320521	6018-6020 6213-6213	6	70-4	1	575,00
70-4733	-320781	6216-6222 6312-6317 6410-6415	19	70-4	1	1236,00
70-4734	-320606	6021 6409	1	70-4	1	247,20
70-4730	-320453	6014-6017	4	70-4	1	480,70

Kugellager-Abzieh-Satz
ST

KS-70-A-K



Ball bearing extractor set
 Jeu d'arrache-roulements à billes
 Kogellagertrekker set
 Juego de extractores de cojinetes de bolas
 Set di estrattori per cuscinetti a sfera
 Zestaw ściągaczy do łożysk kulkowych

Art.-No.			Stück pieces			EUR
KS-70-A-K	-956362	6000-6013 6200-6212 6300-6311 6403-6408	60	L-Boxx	1	1370,60

Lagereinbauwerkzeug-Satz aus Stahl, schwere Ausführung

ST

71



Bearing fitting tool kit made of steel, heavy execution
 Jeu d'outils pour la pose de roulements en acier, usage intensif
 Set stalen lagermontage gereedschap, zware uitvoering
 Juego de herramientas de montaje de cojinetes de acero, versión pesada
 Set di utensili per il montaggio dei cuscinetti in acciaio, versione pesante
 Zestaw narzędzi do montażu łożysk, stal, ciężka wersja

Art.-No.		mm	mm	Stk./pcs.	mm	mm	Stk./pcs.			EUR
71	-314841	10 - 50	26-100	5	15, 20, 30, 40, 55	225	33	L-Boxx	1	1570,00

Lagereinbauwerkzeug-Satz aus Stahl, schwere Ausführung

ST

71-K



Bearing fitting tool kit made of steel, heavy execution
 Jeu d'outils pour la pose de roulements en acier, usage intensif
 Set stalen lagermontage gereedschap, zware uitvoering
 Juego de herramientas de montaje de cojinetes de acero, versión pesada
 Set di utensili per il montaggio dei cuscinetti in acciaio, versione pesante
 Zestaw narzędzi do montażu łożysk, stal, ciężka wersja

Art.-No.		mm	mm	Stk./pcs.	mm	mm	Stk./pcs.			EUR
71-K	-403071	10 - 25	26-47	3	15, 20, 30	77	15	Kunststoff	1	396,90

Lagereinbauwerkzeug-Satz, leichtes Außenmontagemodell

ST

71-L



Bearing fitting tool kit, light out on field model
 Jeu d'outils pour la pose de roulements, exécution légère pour l'utilisation à l'extérieur
 Set lagermontagegereedschap, lichte uitvoering voor montage buitenshuis
 Juego de herramientas de montaje de cojinetes, ejecución ligera para uso en montajes fuera de casa
 Set di utensili per il montaggio dei cuscinetti, modello leggero per montaggio esterno
 Zestaw narzędzi do montażu łożysk, lekki model do montażu zewnętrznego

Art.-No.		mm	mm	Stk./pcs.	mm	mm	Stk./pcs.			EUR
71-L	-782121	10 - 50	26-110	3	19, 32, 50	220	33	L-Boxx	1	546,60

Gewindefeilen

ST

97



Thread files
 Limes pour filetage
 Schroefdraadvijlen
 Limas para reparar roscas
 Lime per filetti
 Pilniki do gwintów



Art.-No.		für for		EUR
97-1	-490231	DIN-ISO	1	85,20
97-2	-490316	Whitworth + BSF	1	85,20
97-3	-490491	SAE / UNF	1	85,20
97-4	-720253	Whitworth G Rohrgewinde	1	85,20

Universal Nachschneider für Außengewinde
ST

97



Universal reamer for external threads
 Outillage de retailage universel pour filetage
 Universele snijmoer voor uitwendige schroefdraad
 Repasador universal para roscas exteriores
 Dente piillante universale per filettature esterne
 Uniwersalny przycinak do gwintów zewnętrznych

Art.-No.		 mm		EUR
97-UGS-1	-341847	4 - 19	1	131,80
97-UGS-2	-341861	17 - 38	1	185,40

Polradabzieher
ST

98







98-1



98-2

Pulse wheel puller
 Extracteur générative
 Vliegwieltrekkers
 Extractor dinamo
 Estrattore per ruota del dinamo
 Ściągacz do wieńców biegunowych





Art.-No.			 mm		EUR
98-1	-433719	M27x1,0	55	1	38,40
98-2	-433733	M26x1,5; M22x1,5	55	1	38,40

Kolbenring-Spannbänder
ST

100



Piston ring compressor
 Colliers pour segments
 Zuigerveer-spanbanden
 Ceñidores de segmentos
 Fasce elastiche per anello del pistone
 Pasy napinające do pierścieni tłokowych





Art.-No.		 mm	 mm	 mm		EUR
100-0	-428203	40	75	50	1	24,60
100-1	-022203	57	125	80	1	37,20
100-2	-022388	90	175	80	1	42,30
100-3	-022463	90	175	165	1	68,70

Kolbenringzangen
ST

101



Piston ring spreaders
 Pincas pour segments de pistons
 Zuigerveertangen
 Tenazas de colocar segmentos
 Pinze per anello del pistone
 Kleszcze do pierścieni tłokowych

Art.-No.		 mm	 mm		EUR
101-1	-022531	50 - 100	200	1	40,80
101-2	-022616	90 - 150	240	1	53,70

Universal-Kolbenring-Auflegezange

ST

101-3

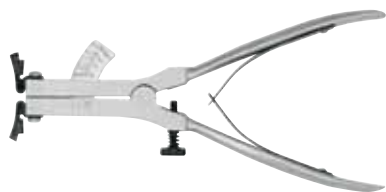

Universal piston ring spreader
 Pince pour segments de pistons universel
 Universele zuigveertang
 Tenaza de colocar segmentos universal
 Pinze universali per inserimento di anello del pistone
 Uniwersalne kleszcze do zakładania pierścieni tłokowych

Art.-No.		 mm		EUR
101-3	-974489	60 - 140	1	205,30

Kolbenbolzen-Drücker

ST

102



Piston pin driver
 Chasse-axes de pistons
 Zuigerpenpersen
 Botadores de bulones de pistones
 Pressori per spinotti
 Wypychacz do sworzni tłokowych

Art.-No.		 mm		EUR
102-0	-170874	38	1	46,60
102-1	-022791	100	1	150,90

Ventilfeder-Spannapparate

ST

103

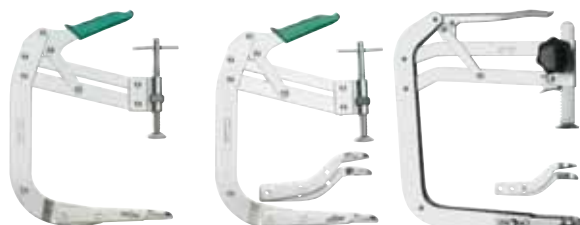

103-1

103-2

103-3

Valve lifters
 Lève-soupapes
 Klepveerlichters
 Compresores de muelles de válvula
 Morsetti alzavalvole
 Aparat do nastawiania zaworów silnika

Art.-No.		 mm		EUR
103-1	-022876	60 - 230	1	54,80
103-2	-022951	40 - 230	1	90,20
103-3	-023378	115 - 290	1	199,30

Bandschlüssel

ST

104



Strap wrench
 Clé à sangle
 Bandsleutel
 Llave de cinta abrazadora
 Chiavi a nastro
 Klucz taśmowy

Art.-No.		 mm		EUR
104	-023606	180	1	34,50

Kettenschlüssel
ST

104



Chain wrench
Clé à chaîne
Kettingsleutel
Llave de cadena
Chiavi a nastro
Klucz łańcuchowy

Art.-No.		\emptyset mm	 inch		EUR
104-32	-790751	0-110	32	1	58,90

Ölfilterschlüssel
ST

105



Oil filter wrench
Clé pour filtres à huile
Oliefiltersleutels
Llave para filtros de aceite
Chiavi per filtri dell'olio
Klucz do filtrów oleju

Art.-No.		\emptyset mm		EUR
105-0	-023866	70-110	1	47,90
105-1	-175749	70-110	1	43,60

Ölfilterschlüssel
ST

108



Oil filter wrench
Clé pour filtres à huile
Oliefiltersleutels
Llave para filtros de aceite
Chiavi per filtri dell'olio
Klucz do filtrów oleju

Art.-No.		\emptyset mm	 mm	 mm		EUR
108-1	-760426	60-100	10 = 3/8"	12,5 = 1/2"	21	40,00
108-2	-965487	65-120	10 = 3/8"	12,5 = 1/2"	21	40,00
108-3	-967900	90-140	12,5 = 1/2"	12,5 = 1/2"	-	213,30

2-armige Universal Abzieher „Techno“
ST

110



Universal 2-arm pullers „Techno“
Arrache roulements „Techno“
Universele 2-armige trekkers „Techno“
Extractors universales de 2 brazos „Techno“
Estrattori universali a 2 bracci „Techno“
2-ramienny ściągacz uniwersalny „Techno“



Art.-No.		 mm	 mm		EUR
110-01	-923753	50	50	1	42,50
110-02	-923760	80	50	1	48,30
110-1	-923777	100	100	1	65,20
110-10	-923784	120	100	1	73,90
110-2	-923791	160	150	1	91,00
110-20	-923807	200	150	1	130,50
110-3	-923814	250	200	1	226,90
110-4	-956317	350	250	1	260,80

2-armige Abzieher für Wälzlager, schwedisches Modell





ST

112



2-arm pullers for roller bearings, swedish model
 Extracteur à 2 bras pour roulements, modèle suédois
 2-armige trekkers voor rollagers, zweeds model
 Extractores de 2 brazos para rodamientos, versión sueca
 Estrattori a 2 bracci per cuscinetti a rulli, modello svedese
 2-ramienny ściągacz do łożysk tocznych, model szwedzki



Art.-No.		 mm	 mm		EUR
112-1	-418143	55	45	1	90,30
112-10	-418891	65	70	1	99,00
112-2	-419218	90	70	1	108,10
112-20	-420283	100	100	1	126,10
112-3	-420368	185	165	1	207,10

3-armige Abzieher für Wälzlager, schwedisches Modell





ST

113



3-arm pullers for roller bearings, swedish model
 Extracteur à 3 bras pour roulements, modèle suédois
 3-armige trekkers voor rollagers, zweeds model
 Extractores de 3 brazos para rodamientos, versión sueca
 Estrattori a 3 bracci per cuscinetti a rulli, modello svedese
 3-ramienny ściągacz do łożysk tocznych, model szwedzki



Art.-No.		 mm	 mm		EUR
113-20	-422423	125	100	1	189,10
113-3	-422751	185	165	1	351,10



Auspuffrohrabschneider

ST

114



Exhaust-pipe Cutter
 Coupe-tuyau d'échappement
 Uitlaat-pijpsnijder
 Cortador de tubos de escape
 Tronchesi per tubo di scarico
 Obcinak do rur wydechowych

Art.-No.		\emptyset mm		EUR
114-1	-892400	80	1	155,00

Abklemmvorrichtung für KFZ-Schlauchleitungen

ST

116



Clipping device for fluid hoses
 Dispositif de déplacage de tuyauteries flexibles automobiles
 Afklemgereedschap voor luxe wagen slangen
 Dispositivo de cierre con clip para mangueras
 Pinza per tubazioni flessibili automobili
 Przyrząd do rozłączania zacisków przewodów giętkich w samochodach

Art.-No.		\emptyset mm		EUR
116-20	-971631	5-20	1	10,00

Abzieher für Nockenwellenräder (VW/Audi)

ST

118



Puller for cam wheels (VW/Audi)
 Extracteur de pignons de distribution (VW/Audi)
 Trekker voor nokkenastandwielen (VW/Audi)
 Extractor de engranajes de mando del árbol de levas (VW/Audi)
 Estrattori per ingranaggi di distribuzione (VW/Audi)
 Ściągacz do kół wałka rozrządu (VW/Audi)

Art.-No.		für for		EUR
118-0	-860904	TDI (4-6-8 Zyl., V6, V8	1	228,60
118-1	-989636	FSI; 2 Liter	1	182,80

Klemmfederspreizer für VW-Auspuffanlagen

ST

119



Clamp spring spreader for VW-exhaust system
 Écarteur de ressorts de retenue pour systèmes d'échappement VW
 Klemveerspanner voor VW-uitlaatsystemen
 Extensor de mueller opresor para instalaciones de gases de escape VW
 Espansore per linguette di fissaggio per impianti di scarico VW
 Rozpieracz zacisków sprężynowych do układów wydechowych VW

Art.-No.		für for		EUR
119-0	-248368	VW	1	90,30

Klemmfeder-Spannkeile-Satz für VW-Auspuffanlagen

ST

119



Set of clamp spring tension wedges for VW-exhaust system
 Jeu de coins de serrange pour ressorts pour systèmes d'échappement VW
 Klemveerspanpie-set voor alle VW-uitlaatsystemen
 Juego de cuñas de apretar de muelle para instalaciones de gases de escape VW
 Set cunei di fissaggio per linguette di fissaggio per impianti di scarico VW
 Zestaw klinów naciągowych do zacisków sprężynowych do układów wydechowych VW

Art.-No.		für for		EUR
119-1	-365904	VW	1	56,10

2-armige Universal Abzieher „Vario“

ST

120



Universal 2-arm pullers „Vario“
 Arrache roulements universels „Vario“
 Universele 2-armige trekkers „Vario“
 Extractores universales de 2 brazos „Vario“
 Estrattori universali a 2 bracci „Vario“
 2-ramienne ściągacze uniwersalne „Vario“

Art.-No.					EUR
		mm	mm		
120-1	-918551	100	100	1	65,90
120-10	-918599	125	100	1	73,90
120-2	-918636	150	150	1	119,20
120-20	-918674	200	150	1	134,30
120-3	-918711	250	200	1	183,90
120-30	-918759	350	200	1	235,20

Verkaufsdisplay „Economy“

ST

120-ST



Sales display „Economy“
 Stand de vente „Economy“
 Verkoopstandaard „Economy“
 Caballete de exhibición „Economy“
 Display di vendita „Economy“
 Display sprzedażowy „Economy“

Art.-No.			Stück pieces		EUR
120-ST	-961489	120-1, 120-10, 120-2, 120-20, 120-3	5	1	576,70

Schraublocher

ST

121



Bolt hole puncher
 Perforateur à vis
 Gatenspenen
 Perforadora de tornillo
 Alesaggi
 Dziurkownik

Art.-No.		Ø		EUR
		mm		
121-182	-831379	18,2	1	91,50
121-260	-831386	26,0	1	91,50
121-266	-403187	26,6	1	91,50
121-319	-403194	31,9	1	91,50
121-326	-403200	32,6	1	91,50
121-346	-403217	34,6	1	91,50
121-389	-403224	38,9	1	91,50

Ausdrückhebel für Scheibenbremsbeläge

ST

123



Disk brake pad remover
 Levier pour la dépose de garnitures de freins à disques
 Hefboom voor schijfremblokken
 Palanca expulsora para forros de frenos de disco
 Leva d'estrazione per pattini di freni a disco
 Dźwignia wypychająca do okładzin hamulców tarczowych

Art.-No.		L	Bezeichnung description		EUR
		mm			
123	-270789		Mercedes	1	38,80
123-2	-431586	400 x 14	Vierkant	1	36,00
123-3	-804243	400 x 17	Sechskant	1	45,20

2-armige Abzieher für Schwingungsdämpfer mit schnellverstellbaren Abzughaken
ST

124



2-jaw puller for vibration dampers with quick adjusting jaws
 Extracteur à 2 bras pour amortisseur de vibrations avec griffes d'extraction à réglage rapide
 2-armige trekkers voor trillingsdempers met snelverstelbare trekhaken
 Extractores de 2 brazos para amortiguador de vibraciones con ganchos de extracción regulables rápidamente
 Estrattori a 2 bracci per ammortizzatori con griffe a regolazione rapida
 2-ramienne ściągacze do amortyzatorów drgań z szybko przestawnymi ramionami



Art.-No.		 mm	Bezeichnung description		EUR
124-20-A	-985140	200	VW T4; VAG Transporter (96)	1	164,10
124-20-B	-985157	225	VW T4; VAG Transporter (96)	1	394,00
124-20-U	-985164	45-200	universal	1	143,70

PKW-Riemenscheibenabzieher-Satz für alle Fahrzeugtypen
ST

124-K

Passenger car V-belt pulley set for all passenger car types
 Jeu d'extraction de poulies de voitures pour poulies de tous genres
 Trekkerset voor v-riemspoelies voor alle personen- en bestelwagens
 Juego de extracción poleas de correas para automóviles de todos tipos
 Set di estrattori per pulegge di autovetture per veicoli di tutti i tipi
 Zestaw ściągaczy do kół pasowych do wszystkich typów samochodów osobowych



Art.-No.		 mm	 mm		EUR
124-K	-736841	195	68 - 88	1	225,10

Bremssattelwerkzeug-Sortiment
ST

126

Brake caliper tools set
 Outillage pour étriers de frein
 Compleet set de remzadelgereedschap
 Herramienta para pinza-soporte
 Assortimento di utensili per pinze dei freni
 Assortymnt narzędzi do zacisków hamulców tarczowych



Art.-No.			Stück pieces		EUR
126-10	-534966	126-00, 126-01, 126-02, 126-03, 126-04, 127	6	1	376,60
126-00	-487774	Kolbenrückstellvorrichtung	1	1	141,30
126-01	-496271	Bremssattel-Auszieher	1	1	14,90
126-02	-496356	Bremssattel Halteklammer	1	1	11,50
126-03	-496431	Bremssattel Drehzange	1	1	126,90
126-04	-534881	Bremssattel-Bürste	1	1	14,90
127	-492051	Bremssattel feile mit Heft mit Flachscher an der Stirnseite	1	1	63,80





Kolbenrückstellwerkzeug-Satz für Scheibenbremsen

ST

126-20



Brake piston reset tools set for disk brakes
 Outillage de rappel de pistons de freins jeu pour freins à disques
 Remzuigerterugstelgereedschap assortiment voor schijfremmen
 Herramientas para retroceso del émbolo juego para frenos de disco
 Set di dispositivi di arretramento del pistoncino per freni a disco
 Zestaw narzędzi do przestawiania tłoków hamulców tarczowych

Art.-No.		 x Stk./pcs.	Stück pieces			EUR
126-20	-509636	6	9	Metall	1	250,80
126-30	-891656	7 (incl. Opel)	10	Metall	1	271,80





Kolbenrückstellwerkzeug-Satz für Scheibenbremsen, rechts- und linksdrehend

ST

126



Piston resetting tool set for disc brakes, right and left handed
 Jeu de dispositifs de rappel de piston pour freins à disques, rotation à droite et à gauche
 Remzuiger-terugstel-gereedschap-set voor schijfremmen, rechts- en linksom draaiend
 Juego de herramientas de retroceso de émbolo para frenos de disco, giratorios en ambos sentidos
 Set di dispositivi di arretramento del pistoncino per freni a disco, con rotazione a sinistra e a destra
 Zestaw narzędzi do przestawiania tłoków hamulców tarczowych, prawo- i lewoskrętny

Art.-No.		 x Stk./pcs.	Stück pieces			EUR
126-40	-920370	10	13	Metall	1	414,10
126-Ford-05	-974496	5	8	Metall	1	295,10





Kugelgelenkabzieher für Mercedes Sprinter, VW-LT ab Bj. 1998 und Ducato ab Bj. 1994

ST

127



Ball joint extractor for Mercedes Sprinter, VW-LT from 1998 manufacture year and Ducato from 1994 manufacture year
 Arrache-rotules pour Mercedes Sprinter, VW LT à partir de l'année 1998 et Ducato à partir de l'année 1994
 Kogelgewrichttrekker voor Mercedes Sprinter, VW-LT v.a. bj. 1998 en Ducato v.a. bj. 1994
 Extractor de rótulas para Mercedes-Benz Sprinter, Volkswagen LT a partir del año de fabricación 1998 y Ducato a partir del año de fabricación 1994
 Estrattori per giunti sferici per Mercedes Sprinter, VW-LT a partire dall'anno di costruzione 1998 e Ducato a partire dall'anno di costruzione 1994
 Ściągacz do przegubów kulowych do Mercedes Sprinter, VW-LT od roku 1998 i Ducato od roku 1994

Art.-No.		 mm	 LH mm		EUR
127-3	-981784	34	63	1	74,90





Universal-Wischerarmabzieher

ST

128-F-SW



Universal wiper-arm puller
 Extracteur universel d'essuie-glace
 Universele trekkers voor ruitenswisserarmen
 Extractor universal de brazos de limpiaparabrisas
 Estrattori universali bracci tergicristallo
 Uniwersalny ściągacz do ramion wycieraczek







Art.-No.		 mm	 mm		EUR
128-F-SW	-971242	60	50	1	75,80

Kugelgelenkabzieher Mercedes Ausführung
ST

128



Ball joint extractors Mercedes type
 Arrache-rotules Model Mercedes
 Kogelgewicht-trekkers Mercedes uitvoering
 Extractores de rótulas Modelo Mercedes
 Estrattori per giunti sferici, modello per Mercedes
 Ściągacz łożysk kulowych, wersja Mercedes





Art.-No.		 mm	 mm	 mm	 mm		EUR
128-1	-024108	18	38	36	17	1	44,90
128-2	-024283	23	48	45	17	1	61,40
128-3	-024368	29	60	60	19	1	81,60
128-4	-024443	40	80	60	24	1	102,20
128-5	-024511	46	100	75	24	1	121,10

Kugelbolzen-Abziehglocke
ST

128-G



Ball joint extractors
 Cloche d'extraction de boulon à rotule
 Kogelbout-trekklok
 Campana extractora del perno de bola
 Estrattori per snodi sferici
 Dzwon ściągający do trzpieni kulistych



Art.-No.		 mm	 mm		EUR
128-G-3	-831324	30	6,5	1	91,50
128-G-4	-831331	39	8,0	1	100,50

Hydraulischer Lenkstockhebelabzieher in Glockenform
ST

128-G



Hydraulic bell-shaped drop arm puller
 Arrache-bielettes pendantes de direction hydraulique en forme de cloche
 Hydraulische stuurkogeltrekker in klokvorm
 Extractor de brazos de mando hidráulico con forma de campana
 Estrattore idraulico braccio di comando a forma di campana
 Hydrauliczny ściągacz dźwigni kierownicy o kształcie dzwonu

Art.-No.		 mm	max. t		EUR
128-G-6-H15	-341724	58	15	1	951,60



Kugelgelenkabzieher

ST

128



Ball joint extractor
Arrache-rotule
Kogelgewricht-trekkers
Extractor de rótulas
Estrattore per giunti sferici
Ściągacz do przegubów kulowych

Art.-No.		 mm	für for		EUR
128-TC	-955556	33	bis 03/2010: Porsche Cayenne; VW Touareg	1	126,00





Kugelgelenk-Ausdrücker mit Hebelübersetzung für PKW

ST

129



Adjustable ball joint extractors lever type for passenger-cars
Arache rotules modèles avec levier pour voitures
Trekkers voor kogelgewrichten met heveloverbrenging voor personenwagens
Extractores de rótulas tipo con leva para los coches
Estrattori per snodi sferici con rapporto di leva per automobili
Wyciskacz do przegubów kulowych z przekładnią dźwigniową do samochodów osobowych

Art.-No.		 mm	 mm	für for		EUR
129-0	-410536	20	50		1	133,20
129-0-25	-989667	25	50	VAG, Universal, kleinere Modelle	1	133,20
129-0-29	-989674	29,5	50	Polo (02), Golf (04/05), Caddy, A 2 (01), A 6(98), A 8 (94), Passat (06), TT (99), Touran (04), LT (97)u.a.	1	133,20
129-0-DC-1	-923920	20	50	Mercedes C	1	155,20
129-0-DC-2	-923647	20	50	Smart	1	136,40





Kugelgelenk-Ausdrücker mit Hebelübersetzung, für PKW und leichte Lieferwagen

ST

129-1



Adjustable ball joint extractors lever type for passenger cars and light commercial vehicles
Arache rotules modèles avec levier pour voitures et camionnettes
Trekkers voor kogelgewrichten met heveloverbrenging voor personen- en lichte bestelwagens
Extractores de rótulas tipo con leva para coches y furgonetas ligeras
Estrattori universali per snodi sferici con rapporto di leva per autovetture e furgoni leggeri
Wyciskacz do przegubów kulowych z przekładnią dźwigniową do samochodów osobowych i lekkich wozów dostawczych





Art.-No.		 mm	 mm	für for		EUR
129-1	-024696	18-22	50		1	90,60
129-1-B-1	-923654	30	50	BMW	1	109,60

Kugelgelenk-Ausdrücker mit Hebelübersetzung, universell für PKW, Lieferwagen und mittlere LKW
ST

129-2



Adjustable ball joint extractors lever type, for all passenger cars, commercial vehicles and medium-sized trucks
 Arache rotules modèles avec levier, universels pour voitures, camionnettes et camions moyens
 Trekkers voor kogelgewrichten met heveloverbrenging voor personen-, bestel- en middelzware vrachtwagens
 Extractores de rótulas tipo con leva, universal para coches, furgonetas y camiones medianos
 Estrattori universali per snodi sferici con rapporto di leva per automobili, autofurgoni e autocarri di medie dimensioni
 Uniwersalny wyciskacz do przegubów kulowych z przekładnią dźwigniową do samochodów osobowych, wozów dostawczych i lekkich sam. ciężarowych





Art.-No.	 4021176	 mm	 mm	für for		EUR
129-2	-024771	16 - 22 - 32	70	universal	1	112,80

Universal-Kugelgelenk-Ausdrücker
ST

129-25



Universal adjustable ball joints extractors
 Arrache-rotules universels
 Universele trekkers voor kogelgewrichten
 Extractores universales de rótulas
 Estrattori universali per snodi sferici con rapporto di leva
 Uniwersalny wyciskacz do przegubów kulowych





Art.-No.	 4021176	 mm	 mm		EUR
129-25	-967924	19	24 - 30 - 40 - 45	1	119,00

Kugelgelenk-Ausdrücker mit Hebelübersetzung, speziell für PKW mit Aluminium-Fahrwerk
ST

129-3-A



Adjustable ball joint extractors lever type, special model for passenger cars with aluminium chassis
 Arache rotules modèles avec levier, spécialement pour voitures à châssis en aluminium
 Trekkers voor kogelgewrichten met heveloverbrenging, speciaal voor personenwagens met aluminium chassis
 Extractores de rótulas tipo con leva, especialmente para los coches con chasis de aluminio
 Estrattori universali per snodi sferici con rapporto di leva, specifici per autovetture con telaio in alluminio
 Wyciskacz do przegubów kulowych z przekładnią dźwigniową do samochodów osobowych z podwoziem aluminiowej

Art.-No.	 4021176	 mm	 mm	für for		EUR
129-3-A	-803178	30	65	ALU	1	138,10
129-3-A-32	-989681	32	65	ALU-Fahrwerke, A 8 ab 03 (hinten)	1	138,10
129-3-A-34	-989698	34	65	ALU-Fahrwerke, A 8 ab 03 (vorne)	1	138,10





Kugelgelenk-Ausdrücker mit Hebelübersetzung, für mittlere LKW, Busse und Baufahrzeuge

ST

129-3/-4



Adjustable ball joint extractors lever type, universal for medium-sized trucks, busses and construction vehicles
 Arrache rotules modèles avec levier, pour camions moyens, bus et véhicules de chantier
 Trekkers voor kogelgewrichten met heveloverbrenging voor middelzware vrachtwagens, bussen en bouwvoertuigen
 Extractores de rótulas tipo con leva, para camiones medianos, autobuses y vehículos de construcción
 Estrattori universali per snodi sferici con rapporto di leva per autocarri di medie dimensioni, autobus e veicoli edili
 Wyciskacz do przegubów kulowych z przekładnią dźwigniową do średnich samochodów ciężarowych, autobusów i maszyn budowlanych

Art.-No.		 mm	 mm	für for		EUR
129-3	-270949	34	70	mittlere LKW, Busse, Baufahrzeuge	1	123,50
129-4	-271021	40	85	schwere LKW, Busse, Baufahrzeuge	1	157,10





Kugelgelenk-Ausdrücker mit kurzer Hydraulikspindel

ST

129-H



Ball joints extractor with short hydraulic spindle
 Arrache-rotule avec vis hydraulique courte
 Kogelgewricht-uitdrukker met korte hydraulische spindel
 Extractor de rótulas con husillo hidráulico corto
 Estrattori per snodi sferici con vite idraulica corta
 Wypychacz przegubów kulowych z krótkim wrzecionem hydraulicznym

Art.-No.		 mm	 mm	mit with	max. t		EUR
129-3-H	-803253	30 - 34	70	800	10	1	288,10
129-4-H	-803666	36 - 40	85	801	15	1	488,10





Spur- und Schubstangengelenk-Abzieher mit hydraulischem Hubzylinder

ST

129-36



Tie and connecting rod joint puller with hydraulic lift cylinder
 Extracteur de rotules à bielle et barres d'accouplement avec cylindre de levage hydraulique
 Spoor- en stuurstangengewricht trekker met hydraulische spindel
 Extractor de articulación de pista y de biela con cilindro de elevación hidráulico
 Estrattore snodo barra trasversale e barra di spinta con cilindro sollevatore idraulico
 Ściągacz przegubów drążka kierowniczego poprzecznego i korbowodu z hydr. cylindrem tłokowym

Art.-No.		 mm	 mm	max. t	für for		EUR
129-36-H	-222894	36	60	10	schwere LKW's, Niederflurbusse, speziell Citaro	1	1507,50
129-36	-865077	36	60	-	Grundgerät / basic device	1	605,70

TIPP:

Nicht im Lieferumfang enthalten sind die hydraulische Pumpe **YHP-320** und der Schlauch **YF-200**. **Diese werden jedoch zum Betätigen des Abziehers benötigt!**





Kugelgelenk-Ausdrücker für schwere LKW

ST

129-5



Adjustable ball joint extractors for heavy trucks
 Arache-rotules pour camions
 Trekkers voor kogelgewrichten voor vrachtwagens
 Extractores de rótulas para camiones
 Estrattori per snodi sferici per autocarri pesanti
 Wyciskacz do przegubów kulowych do samochodów ciężarowych

Art.-No.		 mm	 mm	für for		EUR
129-5	-865084	36	70	mittlere und schwere LKW, Busse, Bau- und Sonderfahrzeuge	1	293,80





Kugelgelenk-Ausdrücker mit Hydraulikspindel, für schwere LKW

ST

129-5-H



Adjustable ball joint extractors with hydraulic ram for heavy trucks
 Trekkers voor kogelgewrichten met hydraulische spindel voor vrachtwagens
 Extractores de rótulas con husillo hidráulico para camiones pesados
 Estrattori per snodi sferici con vite idraulica per autocarri pesanti
 Wyciskacz do przegubów kulowych z wrzcionem hydraulicznym, do samochodów ciężarowych

Art.-No.		 mm	 mm	mit with	max. t	für for		EUR
129-5-H	-865091	36	70	801	15	mittlere und schwere LKW, Busse, Bau- und Sonderfahrzeuge	1	555,10





Spur- und Schubstangengelenk-Abzieher für schwere LKW

ST

129-5-45



Tie and connection rod joint puller for heavy trucks
 Extracteur de rotules à bielle et barres d'accouplement pour camions
 Spoor- en stuurstangengewricht trekker voor zware vrachtwagens
 Extractor de articulación de pista y de biela para camiones pesados
 Estrattore snodo barra trasversale e barra di spinta per autocarri pesanti
 Ściągacz przegubów drążka kierowniczego poprzecznego i korbowodu do ciężkich samochodów ciężarowych

Art.-No.		 mm	 mm	für for		EUR
129-5-45	-333316	35 - 45	120	schwere LKW's, Busse, Niederflurbusse von DAF, IVECO, MAN, Mercedes, Renault, Scania, Volvo	1	367,00

Spur- und Schubstangengelenk-Abzieher mit hydraulischem Hubzylinder

ST

129-5-45-H

hydraulic
TECHNOLOGY

Tie and connecting rod joint puller with hydraulic lift cylinder
 Extracteur de rotules à bielle et barres d'accouplement avec cylindre de levage hydraulique
 Spoor- en stuurstangengewicht trekker met hydraulische spindel
 Extractor de articulación de pista y de biela con cilindro de elevación hidráulico
 Estrattore snodo barra trasversale e barra di spinta con cilindro sollevatore idraulico
 Ściągacz przegubów drążka kierowniczego poprzecznego i korbowodu z hydraulicznym cylindrem tłokowym

Art.-No.		mm	mm	max. t	für for		EUR
129-5-45-H10	-333361	35 - 45	120	10	schwere LKW's, Busse, Niederflrbusse von DAF, IVECO, MAN, Mercedes, Renault, Scania, Volvo	1	1281,40
129-5-45-H20	-333422	35 - 45	120	20	schwere LKW's, Busse, Niederflrbusse von DAF, IVECO, MAN, Mercedes, Renault, Scania, Volvo	1	1491,00

TIPP:

Nicht im Lieferumfang enthalten sind die hydraulische Pumpe **YHP-320** und der Schlauch **YF-200**. Diese werden jedoch zum **Betätigen des Abziehers benötigt!**

LKW-Kugelenk-Ausdrücker „Universal“

ST

129



Ball joints extractor for trucks „Universal“
 Arrache-rotules pour camions „Universal“
 Kogelgewricht-trekkers voor vrachtwagens
 Extractor de rótulas de camiones „Universal“
 Estrattori snodi sferici per autocarri „Universal“
 Wypychacz przegubów kulowych do pojazdów ciężarowych „Universal“

Art.-No.		mm	für for		EUR
129-6	-971662	25-32-47	schweres Werkstattmodell	1	970,60

3-armige Universal Abzieher „Vario“

ST

130



Universal 3-arm pullers „Vario“
 Arrache-roulements universels „Vario“
 Universele 3-armige trekkers „Vario“
 Extractores universales de 3 brazos „Vario“
 Estrattori universali a 3 bracci „Vario“
 3-ramienne ściągacze uniwersalne „Vario“



Art.-No.		mm	mm		EUR
130-10	-918834	110	100	1	92,30
130-2	-918872	150	150	1	145,90
130-20	-918919	200	150	1	183,80
130-3	-918957	250	200	1	286,20

Ablösehebel für Fahrzeug-Türverkleidung
ST

134



Detaching tool for car-door inside panel
 Levier de décollement d'habillage de portes de véhicules
 Demontage hendel voor portierbekleding
 Herramienta de separación para panel interior de puerta de coche
 Leva per rimuovere rivestimento porta autovettura
 Dźwignia do oddzielania okładziny drzwi pojazdów

Art.-No.					EUR
		mm	mm		
134	-975981	175	285	1	21,80

Trenngabeln
ST

135



Fork separators
 Décolleurs à fourches
 Demontagevorken
 Separadores de horquilla
 Forcelle separatrici
 Widełki rozdzielające

Art.-No.				EUR
		mm		
135-1	-024856	18	1	57,30
135-2	-024931	23	1	61,70
135-3	-025013	29	1	63,40
135-4	-025198	39	1	69,30
135-5	-220531	45	1	80,70

Keilauszieh-Zange für Keile in Nuten
ST

139



Key-lifter for keys of slots
 Pince arrache-clavettes pour clavettes bloquées
 Spie-uittrekker voor in de spiegleuf vastzittende spieen
 Pinza extractora de chaveteas para chavetas que asientan firmemente
 Pinza per l'estrazione di chiavette nelle scanalature
 Szczypce do wyciągania klinów w rowkach

Art.-No.							EUR
		mm	mm	mm	mm		
139-1	-779176	122 - 144	0 - 35	110	4	1	658,50





Mini Abzieher für Feinmechanik

ST

Micro



Small-part puller
 Extracteur pour mécanique de précision
 Trekker voor fijnmechanika
 Extractor para mecánica de precisión
 Mini estrattore per meccanica di precisione
 Miniaturowy ściągacz do mechaniki precyzyjnej

Art.-No.		 mm	 mm		EUR
Micro	-974755	20	18	1	70,40





Micro-Abzieher, z.B. für Tachowellen, Manometer, Uhren, Modellbau u.ä.

ST

140



Small-part pullers, e.g. for speedometer cable pullers
 Extracteur pour mécanique de précision, p. ex. por flexibles detachymètres
 Trekker voor fijnmechanika, bijv. voor tachograafassen
 Extractor para mecánica de precisión, p. ej. para árboles flexibles de tacómetros
 Estrattori per pezzi minuscoli, per pezzi flessibili del tachimetro, manometri, orologi e modellistica
 Mikrościągacze, np. do wałków obrotomierzy, manometrów, zegarów, modelarstwa i in.

Art.-No.		 mm	 mm		EUR
140-1	-266720	10	10	1	16,90
140-2	-266737	15	15	1	16,90
140-3	-266751	18	18	1	16,90







Micro-Abzieher-Satz

ST

140-S



Small-part pullers set
 Extracteur pour mécanique de précision
 Trekker voor fijnmechanika
 Extractor para mecánica de precisión
 Set di microestrattori
 Zestaw mikrościągaczy





Art.-No.		 mm	 mm		Stück pieces			EUR
140-S	-951138	10-18	10-18	140-1 140-2 140-3	3	L-Boxx MINI	1	49,00

Universal Scheibenwischer-Abzieher
ST

142



Universal wiper arm puller
 Universal d'extracteurs de bras d'essuie-glaces
 Universele trekker voor ruitenwischer-armen
 Extractores para brazos de limpiaparabrisas
 Estrattori universali per tergicristalli
 Uniwersalny ściągacz wycieraczek





Art.-No.		 mm	LH  mm	 mm		EUR
142-1	-555572	15,0	47,5	2,5	1	93,00
142-2	-555602	23,5	48,0	3,0	1	93,00
142-3	-555619	15,0	29,0	2,5	1	93,00
142-4	-555626	26,5	16,0	5,0	1	93,00
142-5	-260278	11,0	47,5	2,5	1	102,30

Universal Scheibenwischer-Abziehersätze
ST

KS-142

 AUTOGRIP
TECHNOLOGY

Universal wiper arm puller sets
 Jeux universels d'extracteurs de bras d'essuie-glaces
 Universeel trekkersets voor ruitenwischer-armen
 Juegos universales de extractores para brazos de limpiaparabrisas
 Set di estrattori universali per tergicristalli
 Zestawy uniwersalnych ściągaczy wycieraczek

Art.-No.			Stück pieces			EUR
KS-142/6	-555565	142-1, 142-2, 142-3, 142-4, 128-F-SW, 43-1	6	Kunststoff	1	474,70
KS-142/8	-000218	142-1, 142-2, 142-3, 142-4, 142-5, 128-F-SW, 43-1	7	Kunststoff	1	577,10

Zahnrad-Blockiervorrichtung „Multi-Lock“
ST

143



Sprocket „Multi-Lock“ timing device
 Bloque-arbres à cames „Multi-Lock“
 „Multi-Lock“ tandwiel-blokkeerapparaat
 Dispositivo de bloqueo de engranajes „Multi-Lock“
 Dispositivo di bloccaggio con ruota dentata „Multi-Lock“
 Przyrząd blokujący kół zębatych „Multi-Lock“



Art.-No.		für for		EUR
143	-974519	Multi-Lock II	1	215,90

Gegenhalter für Speichenräder
ST

144



Sprocket-holding Tool
 Bloque-roues à rayons
 Tegenhouder voor spaaktandwielen
 Contraapoyo para ruedas de radios
 Controsupporti per ruote a raggi
 Przytrzymywacz do kół ramieniowych

Art.-No.			EUR
144	-974526	1	87,70

Flanschtreiber (Paar)

ST

160



Flange spreaders (Pair)
Chasse-brides (Paire)
Flenzenspreiders (paar)
Separador de bridas (par)
Punzoni a flangia (paio)
Rozwieracze kołnierzy (para)

Art.-No.		 mm		EUR
160-1	-025273	80-250	2	444,90
160-2	-025358	250-1200	2	913,50

Universal Spreizer

ST

165



Universal spreader
Écarteur universel
Universele spreider
Extensor universal
Espansore universale
Rozpierzacz uniwersalny

Art.-No.		 mm	max. t		EUR
165-E	-491979	10 - 75	2	1	1349,70

Farm- und Werkstattabzieher mit verschiedenen langen Abzughaken im Set

ST

200-U



Farm and workshop puller with jaws of varying lengths, in set
Jeu d'extracteurs pour ferme et atelier avec griffes d'extraction de différentes longueurs
Landbouw- en werkplaatstrekker met trekhaken in verschillende lengtes in set
Juego de extractor de taller y de granja con distintos ganchos de extracción largos
Estrattori agricoli e per officina con griffe di varie lunghezze in set
Ściągacz do różnorodnych zastosowań z ramionami o różnej długości w zestawie



Art.-No.		 mm	 mm		EUR
200-U	-025433	250	80 - 180	1	298,60

Farm- und Werkstattabzieher mit verschiedenen langen Abzughaken im Set im Metallkoffer
ST

200-UM



Farm and workshop puller with jaws in varying lengths, in set with metal case
 Jeu d'extracteurs pour ferme et atelier avec griffes d'extraction de différentes longueurs en coffret métallique
 Landbouw- en werkplaatstrekker met trekhaken in verschillende lengtes, set in kist
 Juego de extractor de taller y de granja con distintos ganchos de extracción largos en maletín metálico
 Estrattori agricoli e per officina con griffe di varie lunghezze in set con valigetta in metallo
 Ściągacz do różnorodnych zastosowań z ramionami o różnej długości w zestawie w metalowej walizce



Art.-No.		mm	mm				EUR
200-UM	-025501	250	80 - 180	200-U	Metall	1	400,90

2-armige Universal Abzieher mit umkehrbaren Abzughaken
ST

201



2-arm pullers with reversible double-end jaws
 Extracteur universel à 2 bras avec griffes d'extraction réversibles
 2-armige trekkers met omkeerbare trekhaken
 Extractores universales de 2 brazos con ganchos de extracción reversibles
 Estrattori universali a 2 bracci con griffe intercambiabili
 2-ramienne ściągacze uniwersalne z odwracanymi ramionami



201-0
201-1
201-3
201-4

201-2

Art.-No.		mm	mm		mm	mm		EUR
201-0	-026423	100	75	1	-	14	1	42,80
201-1	-026591	150	85	1	-	17	1	76,70
201-2	-026676	220	130	1	8	22	1	113,80
201-3	-026751	300	260	2	-	27	1	222,60
201-4	-026836	380	300	2	-	27	1	251,40

2-armiger Abzieher für Lüfterräder
ST

201-S



2-arm puller for fan wheels
 Extracteur à 2 bras de rotors de ventilateurs
 2-armige trekker voor ventilatorbladen
 Extractor de 2 brazos para rodetes de ventilador
 Estrattori a 2 bracci per ventole
 2-ramienny ściągacz kół wentylatorów



Art.-No.		mm	mm		mm		EUR
201-S	-026911	200	200	3	17	1	102,20

3-armige Universal Abzieher mit umkehrbaren Abzughaken

ST

202



3-arm pullers with reversible double-end jaws
 Extracteurs à 3 bras à griffes réversibles
 3-armige trekkers met omkeerbare trekhaken
 Extractores de 3 brazos con garras reversibles
 Estrattori universali a 3 bracci con griffe intercambiabili
 3-ramienne ściągacze uniwersalne z odwracanymi ramionami

Art.-No.								EUR
		mm	mm	mm	x	mm		
202-0	-027093	100	75	-	1	14	1	55,50
202-1	-027178	150	85	-	1	17	1	86,40
202-2	-027253	220	130	8	1	22	1	148,80
202-3	-027338	300	260	-	2	27	1	295,50
202-4	-027413	380	300	-	2	27	1	338,40

3-armiger Abzieher für Lüfterräder

ST

202-S



3-arm puller for fan wheels
 Extracteur à 3 bras de rotors ventilateurs
 3-armige trekker voor ventilatorbladen
 Extractor de 3 brazos para rodetes de ventilador
 Estrattori a 3 bracci per ventole
 3-ramienny ściągacz kół wentylatorów

Art.-No.							EUR
		mm	mm	x	mm		
202-S	-027581	200	200	3	17	1	136,70

3-armige Kombi-Abzieher mit umkehrbaren Abzughaken

ST

203



3-arm combination pullers with reversible double-end jaws
 Extracteurs combinés à 3 bras à griffes réversibles
 3-armige combi-trekkers met omkeerbare trekhaken
 Extractores combinados de 3 brazos con garras reversibles
 Estrattori combi a 3 bracci con griffe intercambiabili
 3-ramienne ściągacze kombinowane z odwracanymi ramionami

Art.-No.							EUR
		mm	mm	x	mm		
203-0	-027666	120	75	1	14	1	59,70
203-1	-027741	180	85	1	17	1	91,80
203-2	-027826	280	130	1	22	1	155,80
203-3	-027901	350	260	2	27	1	345,00
203-4	-028083	400	300	2	27	1	387,60

2-armige Lagerabzieher „Cobra“ mit Trennkralle und seitlicher Spannzwinde
ST

204-0



2-arm bearing pullers „Cobra“ with separating claw and side clamp
 Arrache-roulements à 2 bras „Cobra“ avec étrier de serrage latéral
 2-armige lagertrekkers „Cobra“ met zijdelingse spanbeugel
 Extractores de cojinetes de 2 brazos „Cobra“ con tornillo lateral de apriete
 Estrattore per cuscinetti a 2 bracci „Cobra“ con pinze separatrici e dente di fissaggio laterale
 2-ramienny ściągacz uniwersalny „Cobra“ z pazurem rozdzielającym i ścisiskiem bocznym



Art.-No.					EUR
		mm	mm		
204-0	-028168	50	70	1	112,00
204-02	-339516	90	100	1	172,90

2-armige Universal Abzieher mit seitlicher Spannzwinde
ST

204



Universal 2-arm pullers with side clamp
 Extracteurs universels à 2 bras avec étrier de serrage latéral
 Universele 2-armige trekkers met zijdelingse spanbeugel
 Extractores universales de 2 brazos con tornillo lateral de apriete
 Estrattori universali a 2 bracci con dente di fissaggio laterale
 2-ramienne ściągacze uniwersalne ze ścisiskiem bocznym



Art.-No.					EUR
		mm	mm		
204-1	-028243	80	90	1	126,10
204-2	-028328	100	100	1	144,20
204-3	-028403	150	140	1	234,10

Universal-Abziehersatz mit seitlicher Spannzwinde
ST

K-204-2-210-1



Universal puller set with side clamp
 Jeu d'extracteurs universels avec étrier de serrage latéral
 Universeel trekker-set met zijdelingse spanbeugel
 Juego de extractores universales con tornillo lateral de apriete
 Set di estrattori universali con dente di fissaggio laterale
 Zestaw ściągacze uniwersalne ze ścisiskiem bocznym



Art.-No.						EUR
		mm	mm			
K-204-2-210-1	-242106	95-100	100-170	204-2; 210-1	1	392,80

2-armiger Abzieher für Steller an Bremsgestängen

ST

204-30



2-arm puller for brake linkage adjusters
 Extracteur à 2 bras pour organe de réglage sur tringleries de freins
 2-armige trekker voor remsteller van remsystemen
 Extractor de 2 brazos para reguladores en varillajes de frenos
 Estrattore a 2 bracci per tiranti dei freni
 2-ramienne ściągacze do nastawników na przekładniach hamulcowych

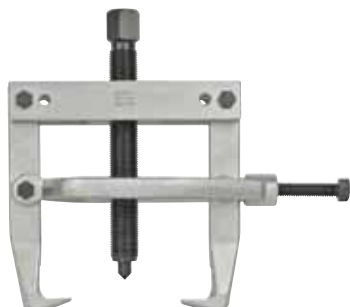

Art.-No.					EUR
204-30	-914379	150 mm	140 mm	1	260,90

Universal-Lenkstockhebelabzieher

ST

204-44



Universal drop arm puller
 Arrache-bielettes pendantes de direction
 Universele stuurstangtrekker
 Extractor de brazos de mando universal
 Estrattore braccio di comando sterzo universale
 Uniwersalny ściągacz dźwigni kierownicy



Art.-No.					EUR
204-44	-969539	90 mm	70 mm	1	104,30

2-armiger Abzieher für Lagerinnenringe „Cobra“ mit seitlicher Spannzwinde

ST

204-V



2-arm puller „Cobra“ for inner races with side clamp
 Arrache-bagues intérieures de roulement à 2 bras „Cobra“ avec étrier de serrage latéral
 2-armige trekker „Cobra“ voor lagerbinnenringen met zijdelingse spanbeugel
 Extractor de 2 brazos para el anillo interior del cojinete „Cobra“ con tornillo lateral de apriete
 Estrattore a 2 bracci „Cobra“ per anello interno dei cuscinetti con dente di fissaggio laterale
 2-ramienne ściągacze do pierścieni wewnętrznych łożysk „Cobra“ ze ściskiem bocznym



Art.-No.					EUR
204-V	-974533	90 mm	100 mm	1	159,60

2-armige Universal Abzieher mit schwenkbaren Abzughaken und verstellbarer Spanntiefe
ST

205



Universal 2-jaw puller with adjustable reach and swiveling jaws
 Extracteur universel à 2 bras avec profondeur de serrage réglable et griffes d'extraction articulées
 2-armige universele trekkers met instelbare spandiepte en zwenkbare trekhaken
 Extractores universales de 2 brazos con profundidad regulable y ganchos de extracción giratorios
 Estrattori universali a 2 bracci con griffe scorrevoli e profondità di serraggio regolabile
 2-ramienne ściągacze uniwersalne o przestawnej głębokości mocowania z ramionami rozwieralnymi



Art.-No.							EUR
		mm	mm		mm		
205-00	-028571	100	100	2	13	1	45,80
205-01	-028656	150	150	2	17	1	63,80
205-02	-028731	250	220	2	22	1	105,80
205-1	-028816	300	280	2	27	1	176,00
205-2	-028991	400	400	3	27	1	216,40
205-3	-029073	500	540	3	27	1	247,60

2-armiger Kombi-Abzieher mit schwenkbaren Abzughaken und verstellbarer Spanntiefe
ST

205



2-armiger Kombi-Abzieher mit schwenkbaren Abzughaken und verstellbarer Spanntiefe
 2-arm combination puller with adjustable reach and swiveling jaws
 Extracteur combiné à 2 bras avec profondeur de serrage réglable et griffes d'extraction articulées
 2-armige combi-trekker met instelbare spandiepte en zwenkbare trekhaken
 Extractores combinados de 3 brazos con profundidad regulable y ganchos de extracción giratorios
 Estrattore combi a 2 bracci con griffe scorrevoli e profondità di serraggio regolabile
 2-ramienny ściągacz kombinowany o przestawnej głębokości mocowania z ramionami rozwieralnymi



Art.-No.							EUR
		mm	mm		mm		
205-65	-880056	650	650	1	41	1	654,70
205-80	-880063	800	800	1	41	1	717,80
205-95	-880049	1000	1000	1	41	1	781,90

2-armige Universal Abzieher mit schwenkbaren Abzughaken, verstellbarer Spanntiefe und langer Hydraulikspindel (inklusive mechanischer Spindel)
ST

205-B



Universal 2-jaw puller with adjustable reach, long hydraulic spindle and swiveling jaws (including mechanical pressure screw)
 Extracteur universel à 2 bras avec profondeur réglable, vis hydr. longue et griffes d'extraction articulées (y compris la vis mécanique)
 2-armige universele trekkers met instelbare spandiepte, lange hydr. spindel en zwenkbare trekhaken (inclusief mechanische spindel)
 Extractores universales de 2 brazos con profundidad regulable, husillo hidr. largo y ganchos de extracción giratorios (con husillo mecánico)
 Estrattori universali a 2 bracci con griffe scorrevoli, profondità di serraggio regolabile e vite idraulica lunga (con vite meccanico)
 2-ramienne ściągacze uniwersalne o przestawnej głębokości mocowania, z długim wrzecionem hydraulicznym i ramionami rozwieralnymi (z wrzecionem mechanicznym)



Art.-No.				max. t		mit with		EUR
		mm	mm					
205-02-B	-886072	250	220	7	2	8-01	1	331,60
205-1-B	-886089	300	280	12	2	8-02	1	412,90
205-2-B	-886096	400	400	12	3	8-02	1	448,30
205-3-B	-886102	500	540	12	3	8-02	1	479,50

3-armige Universal Abzieher mit schwenkbaren Abzughaken und verstellbarer Spanntiefe

ST

206



Universal 3-jaw puller with adjustable reach and adjustable swiveling jaws
 Extracteur universel à 3 bras avec profondeur réglable et griffes d'extraction articulées
 3-armige universele trekkers met instelbare spandiepte en zwenkbare trekhaken
 Extractores universales de 3 brazos con profundidad regulable y ganchos de extracción giratorios
 Estrattori universali a 3 bracci con griffe scorrevoli e profondità di serraggio regolabile
 3-ramienne ściągacze uniwersalne o przestawnej głębokości mocowania z ramionami rozwieralnymi



Art.-No.	40211761	mm	mm	x	mm		EUR
206-00	-029158	100	100	2	13	1	61,70
206-01	-029233	150	150	2	17	1	81,90
206-02	-029318	250	220	2	22	1	137,20
206-1	-029493	300	280	2	27	1	225,70
206-2	-029561	400	400	3	27	1	284,30
206-3	-029646	500	540	3	27	1	330,90

3-armige Universal Abzieher mit verstellbarer Spanntiefe, langer Hydraulikspindel und schwenkbaren Abzughaken (inklusive mechanischer Spindel)

ST

206-B



Universal 3-jaw puller with adjustable reach, long hydraulic spindle and swiveling jaws (including mechanical pressure screw)
 Extracteur universel à 3 bras avec profondeur réglable, vis hydraulique longue et griffes d'extraction articulées (y compris la vis mécanique)
 3-armige universele trekkers met instelbare spandiepte, lange hydraulische spindel en zwenkbare trekhaken (inclusief mechanische spindel)
 Extractores universales de 3 brazos con profundidad regulable, husillo hidráulico largo y ganchos de extracción giratorios (con husillo mecánico)
 Estrattori universali a 3 bracci con profondità di serraggio regolabile, vite idraulica lunga e griffe scorrevoli (con vite meccanico)
 3-ramienne ściągacze uniwersalne o przestawnej głębokości mocowania, z długim wrzecionem hydraulicznym i ramionami rozwieralnymi (z wrzecionem mechanicznym)



Art.-No.	40211761	mm	mm	x	max. t	mit with		EUR
206-02-B	-886119	100	100	2	7	8-01	1	362,60
206-1-B	-412448	300	280	2	10	8-02	1	480,30
206-2-B	-886126	400	400	3	10	8-02	1	536,30
206-3-B	-886133	500	540	3	12	8-02	1	579,70

3-armige Kombi-Abzieher mit schwenkbaren Abzughaken und verstellbarer Spanntiefe

ST

207



3-jaw combination puller with adjustable reach and swiveling jaws
 Extracteur combiné à 3 bras avec profondeur réglable et griffes d'extraction articulées
 3-armige combi trekkers met instelbare spandiepte en zwenkbare trekhaken
 Extractores combinados de 3 brazos con profundidad regulable y ganchos de extracción giratorios
 Estrattore combi a 3 bracci con griffe scorrevoli e profondità di serraggio regolabile
 3-ramienne ściągacze kombinowane o przestawnej głębokości mocowania z ramionami rozwieralnymi



Art.-No.							EUR
		mm	mm		mm		
207-00	-029721	120	100	2	13	1	64,40
207-01	-029806	200	150	2	17	1	86,80
207-02	-029981	300	220	2	22	1	144,50
207-1	-030048	400	280	2	27	1	274,70
207-2	-030123	450	400	3	27	1	333,20
207-3	-030208	550	540	3	27	1	380,20
207-65	-880100	650	650	1	41	1	837,10
207-80	-880117	800	800	1	41	1	931,60
207-95	-880094	1000	1000	1	41	1	1026,80

3-armige Kombi-Abzieher mit verstellbarer Spanntiefe, langer Hydraulikspindel und schwenkbaren Abzughaken (inklusive mechanischer Spindel)

ST

207-B

3-jaw combination puller with adjustable reach, long hydraulic spindle and swiveling jaws (including mechanical pressure screw)
 Extracteur combiné à 3 bras avec profondeur réglable, vis hydr. longue et griffes d'extraction articulées (y compris la vis mécanique)
 3-armige combi trekkers met instelbare spandiepte, lange hydr. spindel en zwenkbare trekhaken (inclusief mechanische spindel)
 Extractores combinados de 3 brazos con profundidad regulable, husillo hydr. largo y ganchos de extracción giratorios (con husillo mecánico)
 Estrattori combi a 3 bracci con profondità di serraggio regolabile, vite idraulica lunga e griffe scorrevoli (con vite meccanico)
 3-ramienne ściągacze kombinowane o przestawnej głębokości mocowania z długim wrzecionem hydraulicznym i ramionami rozwieralnymi (z wrzecionem mechanicznym)



Art.-No.					max. t	mit		EUR
		mm	mm					
207-02-B	-886140	300	170	2	7	8-01	1	370,00
207-1-B	-886157	400	230	2	10	8-02	1	511,70
207-2-B	-886164	450	350	3	10	8-02	1	565,00
207-3-B	-886171	550	490	3	12	8-02	1	611,80

2-armige Universal Abzieher mit schwenkbaren Abzughaken und verstellbarer Spanntiefe

ST

208



Universal 2-jaw puller with adjustable reach and swiveling jaws
 Extracteur universel à 2 bras avec profondeur de serrage réglable et griffes d'extraction articulées
 2-armige universele trekkers met instelbare spandiepte en zwenkbare trekhaken
 Extractores universales de 2 brazos con profundidad regulable y ganchos de extracción giratorios
 Estrattori universali a 2 bracci con griffe scorrevoli e profondità di serraggio regolabile
 2-ramienne ściągacze uniwersalne o przestawnej głębokości mocowania z ramionami rozwieralnymi



Art.-No.							EUR
		mm	mm		mm		
208-01	-432408	20 - 170	95 - 125	2	17	1	62,50
208-02	-432651	20 - 230	150 - 190	2	22	1	101,70

2-armiger Abzieher mit umkehrbaren Abzughaken

ST

208-0



2-arm puller with reversible double-end jaws
 Extracteur à 2 bras à griffes réversibles
 2-armige trekker met omkeerbare trekhaken
 Extractor de 2 brazos con garras reversibles
 Estrattore a 2 bracci con griffe intercambiabili
 2-ramienny ściągacz z odwracanymi ramionami



Art.-No.							EUR
		mm	mm		mm		
208-0	-432248	100	50 - 100	2	8	1	38,00

2-armiger Universal Abzieher „Economy“ mit schwenkbaren Abzughaken, verstellbarer Spanntiefe und langer Hydraulikspindel

ST

208-2-B



Universal 2-jaw „economy“ puller with adjustable reach, long hydraulic spindle and swiveling jaws
 Extracteur universel « Economy » à 2 bras avec profondeur réglable, vis hydraulique longue et griffes d'extraction articulées
 2-armige universele trekker „Economy“ met instelbare spandiepte, lange hydraulische spindel en zwenkbare trekhaken
 Extractor universal de 2 brazos «Economy» con profundidad regulable, husillo hidráulico largo y ganchos de extracción giratorios
 Estrattore universale a 2 bracci „Economy“ con griffe scorrevoli, profondità di serraggio regolabile e vite idraulica lunga
 2-ramienny ściągacz uniwersalny „Economy“ o przestawnej głębokości mocowania z długim wrzecionem hydraulicznym i ramionami rozwieralnymi



Art.-No.					max. t		EUR
		mm	mm				
208-2-B	-432811	400	225 - 400	3	12	1	512,50

3-armiger Universal Abzieher mit schwenkbaren Abzughaken und verstellbarer Spanntiefe

ST

209



Universal 3-jaw puller with adjustable reach and adjustable swiveling jaws
 Extracteur universel à 3 bras avec profondeur réglable et griffes d'extraction articulées
 3-armige universele trekkers met instelbare spandiepte en zwenkbare trekhaken
 Extractores universales de 3 brazos con profundidad regulable y ganchos de extracción giratorios
 Estrattori universali a 3 bracci con griffe scorrevoli e profondità di serraggio regolabile
 3-ramienne ściągacze uniwersalne o przestawnej głębokości mocowania z ramionami rozwieralnymi



Art.-No.							EUR
		mm	mm		mm		
209-01	-432576	20 - 170	95 - 125	2	17	1	86,50
209-02	-432736	20 - 230	150 - 190	2	22	1	130,70

3-armiger Universal Abzieher mit umkehrbaren Abzughaken
ST

209-0



3-arm puller with reversible double-end jaws
 Extracteur à 3 bras à griffes réversibles
 3-armige universele trekker met omkeerbare trekhaken
 Extractor de 3 brazos con garras reversibles
 Estrattore universale a 3 bracci con griffe intercambiabili
 3-ramienny ściągacz uniwersalny z odwracanymi ramionami

Art.-No.							EUR
		mm	mm		mm		
209-0	-432323	100	50 - 100	2	8	1	51,00

3-armiger Universal Abzieher „Economy“ mit schwenkbaren Abzughaken, verstellbarer Spanntiefe und langer Hydraulikspindel
ST

209-2-B



Universal 3-jaw „economy“ puller with adjustable reach, long hydraulic spindle and swiveling jaws
 Extracteur universel „Economy“ à 3 bras avec profondeur réglable, vis hydraulique longue et griffes d'extraction articulées
 3-armige universele trekker „Economy“ met instelbare spandiepte, lange hydraulische spindel en zwenkbare trekhaken
 Extractor universal de 3 brazos «Economy» con profundidad regulable, husillo hidráulico largo y ganchos de extracción giratorios
 Estrattore universale a 3 bracci „Economy“ con griffe scorrevoli, profondità di serraggio regolabile e vite idraulica lunga
 3-ramienny ściągacz uniwersalny „Economy“ o przestawnej głębokości mocowania z długim wrzecionem hydraulicznym i ramionami rozwieralnymi

Art.-No.					max. t		EUR
		mm	mm				
209-2-B	-432996	500	225 - 400	3	15	1	826,10

2-armige Trennabzieher „Cobra“ mit verstellbarer Spanntiefe
ST

210



2-arm separator pullers „Cobra“ with adjustable reach
 Extracteurs-décolleurs à 2 bras „Cobra“ à profondeur réglable
 2-armige schneidende trekkers „Cobra“ met instelbare spandiepte
 Separadores-extractores de 2 brazos „Cobra“ con profundidad regulable
 Estrattori separatori a 2 bracci „Cobra“ con profondità di serraggio regolabile
 2-ramienny ściągacz rozdzielający „Cobra“ o przestawnej głębokości mocowania

Art.-No.							EUR
		mm	mm		mm		
210-1	-030383	95	170	4	22	1	211,40
210-2	-030468	135	270	5	24	1	263,40
210-3	-030536	150	325	5	24	1	301,90

Spannzwinde für 2-armige Abzieher
ST

219



Clamp for 2-arm pullers
 Serre-joint de extracteur à 2 bras
 Spanbeugel voor 2-armige trekkers
 Tornillo de apriete para extractores de 2 brazos
 Dente di fissaggio per estrattori a 2 bracci
 Ścisk do ściągaczy 2-ramiennych

Art.-No.						EUR
		mm	mm			
219-1	-777777	40-190	8	20-1, 20-10	1	61,00

Universalabzieher mit Gleithammer

ST

220

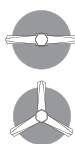

Universal puller with slide hammer
 Extracteur universel à masse coulissante
 Universele trekker met glijhamer
 Extractor universal con martillo de correa
 Estrattori universali con battente
 Ściągacz uniwersalny z młotkiem ślizgowym

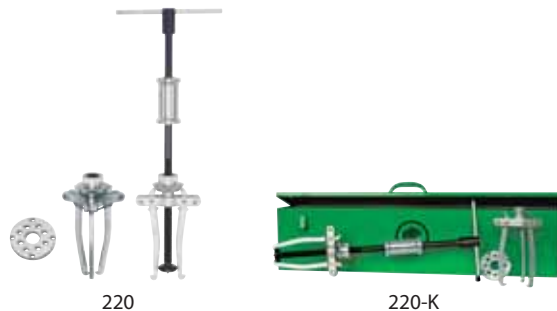

220

220-K

Art.-No.		mm	mm			EUR
220	-030611	0 - 200	165	220-02, 220-03	1	468,00
220-K	-874055	0 - 200	165	220-02, 220-03	1	548,10

2-armiger Abzieher mit konischer Selbstspannung

ST

220



2-arm puller with cone-driven spread adjuster
 Extracteur à 2 bras à guidage conique
 2-armige trekker met conische zelfcentering
 Extractor de 2 brazos con ajuste del alcance guiado por cono
 Estrattore a 2 bracci con autocentraggio conico
 2-ramienny ściągacz ze stożkowym mechanizmem samozaciskowym



Art.-No.		mm	mm		EUR
220-02	-778919	200	165	1	217,90

3-armiger Abzieher mit konischer Selbstspannung

ST

220-03



3-jaw puller with cone-driven spread adjuster
 Extracteur à 3 bras avec guidage conique
 3-armige trekker met conische zelfcentering
 Extractor de 3 brazos con ajuste del alcance guiado por cono
 Estrattore a 3 bracci con autocentraggio conico
 3-ramienny ściągacz ze stożkowym mechanizmem samozaciskowym



Art.-No.		mm	mm		EUR
220-03	-779091	200	165	1	252,90

Innenauszieher mit Gleithammer

ST

221-G

Internal extractor with slide hammer
 Extracteur intérieur à masse coulissante
 Binnentrekker met glijhamer
 Extractor interior con martillo de correa
 Estrattori interni con battente
 Ściągacz wewnętrzny z młotkiem ślizgowym



Art.-No.		\varnothing mm	mm	mm		EUR
221-G	-175824	30-180	140	150	1	341,00

Dichtring-Demontage-Werkzeuge
ST

222





222-1



222-U



Seal disassembly tools
 Outillage de démontage des joints d'étanchéité
 Demontage gereedschappen voor afdichtingen
 Herramientas de desmontaje del anillo obturador
 Attrezzi per lo smontaggio dell'anello di tenuta (anelli di guarnizione)
 Narzędzia do demontażu pierścieni uszczelniających





Art.-No.		 L mm	 mm		EUR
222-1	-035722	430	230	1	54,90
222-U	-777790	300	-	1	53,70

Dichtring-Ausziehsatz (Simmerringe) im Koffer
ST

KS-222-1/7



Seal pulling set (gasket) in case
 Jeu de décolleurs de joints d'étanchéité (bagues de garniture) en coffret
 Trekkerset voor afdichtingen (Simmerringen) in koffer
 Juego de extractores de anillos obturadores (aros de retención) en maletín
 Set di estrazione anello di tenuta (anelli di guarnizione) in una valigetta
 Zestaw ściągaczy do pierścieni uszczelniających (dociskanych sprężyną) w walizce





Art.-No.			Stück pieces			EUR
KS-222-1/7	-111112	222-1, 222-100, 222-U	9	Kunststoff	1	322,90

Abzieher für Teile mit Gewindelöchern
ST

223



Extractor for parts with tapholes
 Extracteur pour pièces à trous taraudés
 Trekker voor delen met schroefdraadgaten
 Extractor para piezas con agujeros roscados
 Estrattori per pezzi filettati
 Ściągacz do części z otworami pod gwint

Art.-No.			 mm	 kg		EUR
223	-309083	M3; M4; M5; M6; M8; M10; M12; M14; M16; M18	225	0,9	1	141,20

Passfeder- und Passtiftauszieher-Satz

ST

223-K



Set of parallel-key and dowel-pin extractors
 Jeu d'arrache-clavettes et arrache-pions de centrage
 Pasveer- en paspentrekker-set
 Juego de extractores de chavetas y pasadores de ajuste
 Set di estrattori per chiavette piatte e perni di regolazione
 Zestaw ściągaczy do wpustów pasowanych i kołków pasowanych

Art.-No.					Stück pieces			EUR
			mm	kg				
223-K	-784859	M3; M4; M5; M6; M8; M10; M12; M14; M16; M18	225	0,9	12	i-Boxx	1	226,20
223-G	-984181	M8; M10; M12; M14; M16; M18; M20; M22; M24	270	1,7	11	i-Boxx	1	369,50

Innenauszieher mit Gleithammer

ST

224

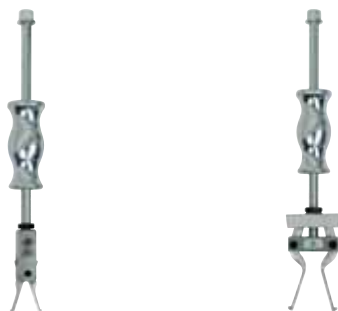

Internal extractor with slide hammer
 Extracteur intérieur à masse coulissante
 Binnentrekker met glijhamer
 Extractor interior con martillo de correa
 Estrattori interni con battente
 Ściągacz wewnętrzny z młotkiem ślizgowym

Art.-No.		∅				EUR
		mm	mm	mm		
224-1	-325656	12-35	25	305	1	185,40
224-2	-325571	15-50	50	290	1	173,50

Staubkappen-Ein- und Auszieher mit Gleithammer und selbstzentrierenden Abzughaken

ST

225



Dust cover inserter and extractor with slide hammer and self-centering jaws
 Appareil de pose et extracteur de pare-poussière à masse coulissante et griffes d'extraction autocentrées
 Stofkap in- en uittrekgereedschap met glijhamer en zelfcenterende trekhaken
 Introdutor y extractor de tapas de polvo con martillo de correa y con ganchos de extracción autocentrantes
 Dispositivi di estrazione con cappucci di protezione antipolvere, battente e griffe autocentranti
 Naciągacz i ściągacz do pokryw przeciwpyłowych z młotkiem ślizgowym i samocentrującymi ramionami

Art.-No.					EUR
		mm	mm		
225-DC	-924132	65	225	1	447,80

Abziehvorrichtung für LKW-Achsen
ST

226



226-4/11



K-226-4/12



Pulling device
 Extracteur moyeu
 Trekkerset voor vrachtwagen assen
 Dispositivo extractor para ejes de camiones
 Dispositivo estrattore per assi di autocarri
 Przyrząd ściągający do osi samochodów ciężarowych

Art.-No.		für for	mit with	max. t			EUR
226-4/11	-831362	Sauer. BTW, Bergische Achsen	-	-	1	-	761,40
K-226-4/12	-035753	Sauer. BTW, Bergische Achsen	9-2	15	1	Kunststoff	968,20

Universal-Gleithammer
ST

229



229-1



229-1-2

Universal slide hammer devices
 Dispositifs à masse coulissante universel
 Glijhamer-gereedschap universeel
 Martillos de correa universal
 Battente universale
 Uniwersalny młotek ślizgowy

Art.-No.		 mm			EUR
229-1	-995002	340	22-0-2, 229-01	1	427,80
229-1-2	-545733	340	22-0-2, 229-03	1	644,40
229-01	-117329	Haken mit Knickgelenk für 22-0-2		1	93,20
22-0-2-100	-111211	Zusatzgewicht (3 kg) für 22-0-2		1	136,00

Radnabenabzieher
ST

229

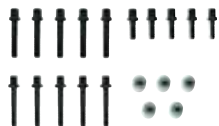
 229-2
 229-3

229-3/20



Hub puller
 Arrache-moyeux
 Wielnaaftrekkers
 Ectractor para cubos
 Estrattore per mozzo oi ruote
 Ściągacz piasty kola

Art.-No.		max. t			EUR
229-2	-995026	10	229-1	1	354,60
229-3	-995033	15	229-1	1	472,70
229-03	-117336	Radnabzieher ohne Hydraulikspindel		1	186,30
229-3/20	-229329	Radnaben-/ Gelenkwellendmontage-Ergänzungssatz		1	70,00
229-100	-995019	Adapter		1	43,00





Steckachsenabzieher

ST

230



Flang type axle puller
 Extracteur de demi-arbres
 Steekas-slagtrekker
 Extractor de semiejes
 Estrattore albero di trasmissione
 Ściągacz osi

Art.-No.		 mm	 mm	 mm		EUR
230	-031038	4-14	100-150	265	1	194,90
230-S	-893377	4-14	100-150	-	1	106,20

Ausschlagwerkzeug für Injektoren

ST

230-I



Deflection tool for injectors
 Outil de déflexion pour injecteurs
 Slagtrekker voor injectoren
 Extractor de horquilla para inyectoros
 Deflettore per valvole d'iniezione
 Narzędzie do wybijania wtryskiwaczy

Art.-No.		für for	 mm		EUR
230-I	-977626	MB CDI	280	1	232,90

Selbstzentrierender Universal-Abzieher mit Schlaghammer





ST

243



Self centering universal jaw puller with slide hammer
 Extracteur autocentreuse universel à masse coulissante
 Zelfcenterende universele slagtrekker
 Extractor autocentrante universal con martillo de correa
 Estrattore universale autocentrante con martello a percussione
 Samocentrujący ściągacz uniwersalny z młotkiem udarowym



Art.-No.		 mm	 mm	 mm		EUR
243-12	-924170	70	70	225	1	130,50

2-armige Universal Abzieher mit Autogrip
ST

482



Universal 2-arm pullers with Autogrip
 Extracteur universel à 2 bras avec Autogrip
 Universele 2-armige trekkers met Autogrip
 Extractor universal de 2 brazos con Autogrip
 Estrattori universali a 2 bracci con Autogrip
 2-ramienne ściągacze uniwersalne z uchwytem Autogrip



482-1

482-2

 482-3
 482-4
 482-5

Art.-No.		 mm	 mm		EUR
482-1	-479779	60	40	1	44,80
482-2	-479854	85	90	1	64,80
482-3	-479939	150	150	1	122,50
482-4	-480096	200	200	1	144,20
482-5	-480171	250	250	1	148,40

3-armige Universal Abzieher mit Autogrip
ST

483



Universal 2-arm pullers with Autogrip
 Extracteurs universels à 3 bras avec Autogrip
 Universele 3-armige trekkers met Autogrip
 Extractores universales de 3 brazos con Autogrip
 Estrattori universali a 2 bracci con Autogrip
 3-ramienne ściągacze uniwersalne z uchwytem Autogrip



Art.-No.		 mm	 mm		EUR
483-2	-480331	85	90	1	90,40
483-3	-480416	150	150	1	145,00
483-4	-480584	200	200	1	168,80
483-5	-480669	250	250	1	198,10

2-armige Universal-Abzieher mit Autogrip im Set
ST

482-DP



2-arm Autogrip pullers in display package
 Extracteurs Autogrip à 2 bras en display
 2-armige Autogrip trekkers in display-karton
 Extractores Autogrip de 2 brazos en encase de display
 Estrattori universali a 2 bracci con Autogrip in set
 2-ramienne ściągacze uniwersalne z uchwytem Autogrip w zestawie



Art.-No.			Stück pieces			EUR
482-DP	-745836	482-1, 482-2, 482-3	3	i-Boxx	1	263,80

2- und 3-armige Universal-Abzieher mit Autogrip in Rolltasche

ST

482/483

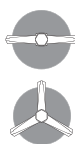
Set of 2- and 3-arm Autogrip pullers
 Jeu d'extracteurs Autogrip à 2- et 3 bras
 2- en 3-armige Autogrip trekkers-set
 Juego de extractores Autogrip de 2 y de 3 brazos
 Estrattori universali a 2 e 3 bracci con Autogrip borsa avvolgibile
 2- i 3-ramienne ściągacze uniwersalne z uchwytem Autogrip w torbie rolowanej

Art.-No.		 mm	 mm		Stück pieces		EUR
482-1-2-3-T	-500008	0 - 150	0 - 150	482-1, 482-2, 482-3	3	1	243,10
482/483-2-T	-500015	0 - 85	0 - 90	482-2, 483-2	2	1	159,20
482/483-3-T	-500022	0 - 150	0 - 150	482-3, 483-3	2	1	287,30

Druckstück-Baukasten

ST

600-17



Pressure pad bricks
 Jeu d'embouts de pression
 Spindeldrukstukken set
 Juego de piezas de presión
 Kit di pressori
 Klocki dociskowe

Art.-No.		\emptyset mm		EUR
600-17	-914188	20; 32; 41	1	23,60

Sicherungsringzangen für Außenringe

ST

728



728T-A0
728T-A1
728T-A2
728T-A3
728T-A4

728T-A01
728T-A11
728T-A21
728T-A31
728T-A41

Circlip pliers, external
 Pincers pour circlips extérieurs
 Segerring tangen voor uitwendige ringen
 Alicates para segmentos de retención exteriores
 Pinze per anelli di sicurezza per anelli esterni
 Szczypce do zewnętrznych pierścieni zabezpieczających

Art.-No.		 mm	 mm		EUR
728T-A0	-139567	3 - 10	135	6	23,50
728T-A1	-790546	10 - 25	135	6	23,60
728T-A2	-790560	19 - 60	180	6	23,60
728T-A3	-545764	40 - 100	225	6	33,80
728T-A4	-790591	85 - 140	320	6	49,50
728T-A01	-545757	3 - 10	135	6	25,00
728T-A11	-790553	10 - 25	135	6	25,00
728T-A21	-790577	19 - 60	180	6	28,00
728T-A31	-790584	40 - 100	225	6	33,80
728T-A41	-545771	85 - 140	320	6	49,50

Mechanische Druckspindeln passend für Kukko-Abzieher

- KUKKO Druckspindeln mit gewalzttem Gewinde sind speziell für die Verwendung in unseren Abziehern entwickelt.
- Die Druckspindeln sind spezialbeschichtet und garantieren so eine besonders gute Gleiteigenschaft im Gewindegang.
- Die gelagerte, freidrehende Zentrierspitze schützt die Welle vor Beschädigungen beim Aufbringen der Abziehkraft.
- Die Spindelköpfe sind mit einem Bund versehen, der verhindert, dass der Schraubenschlüssel beim Abziehvorgang abrutscht.
- Der Spindelkopf und der Spindelbund sind mit der Artikel-Nummer gelasert.



Mechanische Spindel



Art.-No.

6

14

160

Druckspindel
Pressure screw

Ø
mm

L
mm

Pflege der Abzieher-Spindel

Die Spindel ist immer gut gefettet zu halten.



Wir empfehlen die Verwendung von KUKKO Spezialfett für Druckspindeln (Art.-No.: 699999) oder von KUKKO Bio-Multi-Öl (Art.-No.: 699990).

Eine Tube KUKKO Spezialfett für Druckspindeln liegt jedem Original KUKKO Abzieher gratis bei.

699999



699990



Preis Gruppen
Price categories
Catégories de prix
Categorías de precios
Prijs categoriën

Kategorie		EURO
PG 0	1	8,00
PG 1	1	11,00
PG 2	1	34,00
PG 3	1	43,00
PG 4	1	70,00
PG 5	1	100,00
PG 6	1	125,00
PG 7	1	165,00
PG 8	1	220,00
PG 9	1	290,00
PG 10	1	425,00
PG 11	1	575,00
PG 12	1	900,00

Gewinde	Art.-No.		passend zu	Gewinde			SW mm						PG		
					mm	mm									
M 8	608080	-176241	48, 482-1	M 8	8	80	-	-	X	-	X	-	1		
	608130	-481086	482-2, 483-2	M 8	8	130	-	-	X	-	X	-	1		
M 9	609087	-102493	41-1, 42-1, 43-1, 43-11, 43-12, 43-2	M 9	9	87	-	-	X	-	X	-	1		
	609105	-101403	41-2, 42-2, 43-3, 43-13	M 9	9	105	-	-	X	-	X	-	1		
M 10	610070	-362446	41-0, 42-0	M 10	10	75	13	X	-	-	X	-	1		
	610094	-122118	204-0	M 10	10	94	-	-	X	-	-	X	1		
	610110	-433726	208-0, 209-0, 112-1, 112-10	M 10	10	120	8	X	-	-	-	X	1		
M 12x1,5	612080	-238468	201-0, 202-0, 203-0	M 12x1,5	12	85	14	X	-	X	-	-	2		
	612110	-112881	205-00, 206-00, 207-00	M 12x1,5	12	110	13	X	-	X	-	-	2		
	612130	-077081	18-0, 44-1, 45-1	M 12x1,5	12	130	13	X	-	X	-	-	2		
	612131	-425073	14-01, 14-1	M 12x1,5	12	130	13	X	-	-	-	X	2		
	612150	-790201	41-3, 42-3	M 12x1,5	12	150	13	X	-	X	-	-	2		
M 12	612200	-480744	482-3, 483-3	M 12	12	210	10	X	-	-	-	X	2		
M 14x1,5	614135	-074271	12-1, 30-1, 30-1+, 30-1-2, 30-10, 30-10+, 30-10-2, 32-1, 33, 112-2, 201-1, 202-1, 203-1 30-1-S, 30-1+S, 30-10-S, 30-10+S, 30-10SP, 30-1-S-T, 30-10-S-T, 30-1+S-T, 30-10+S-T,	M 14x1,5	14	135	17	X	-	X	-	-	-	2	
	614160	-112966	20-1, 20-10, 20-10-V, 44-2, 45-2, 112-20, 113-20, 205-01, 206-01, 207-01, 208-01, 209-01 20-1-S, 20-10-S, 20-1+S, 20-10+S	M 14x1,5	14	160	17	X	-	X	-	-	2		
	614200	-838576	41-4, 42-4	M 14x1,5	14	200	17	X	-	X	-	-	2		
	614241	-976940	70-2, 201-S, 202-S	M 14x1,5	14	240	17	X	-	X	-	-	2		
	614250	-306709		M 14x1,5	14	250	17	X	-	X	-	-	2		
	M 16	616160	-284236	14-2	M 16	16	145	17	X	-	-	-	X	2	
616202		-264351	14-3, 14-03	M 16	16	185	17	X	-	-	-	X	2		
616270		-480829	482-4, 483-4	M 16	16	270	13	X	-	-	-	X	3		
616325		-480904	482-5, 483-5	M 16	16	325	13	X	-	-	-	X	3		
M 16x1,5	616220	-420856	112-3, 113-3	M 16x1,5	16	220	17	X	-	X	-	-	3		
M 18x1,5	618105	-073779	17-2, 204-1	M 18x1,5	18	105	19	X	-	X	-	-	2		
	618175	-074356	12-2, 18-1, 32-2	M 18x1,5	18	175	19	X	-	X	-	-	2		
	618210	-113048	44-3, 45-3	M 18x1,5	18	210	19	X	-	X	-	-	2		
M 20*	620162	-816040	28-1	M 20*	20	160	24	X	X	-	-	X	4		
	620172	-817946	28-2	M 20*	20	170	24	X	X	-	-	X	5		
	620230	-818028	28-3	M 20*	20	230	24	X	X	-	-	X	5		
	620250	-818103	28-4	M 20*	20	250	24	X	X	-	-	X	5		
G 1/2"	621130	-124358	204-2, 204-02	G 1/2"	20,955	130	22	X	-	X	-	-	3		
	621220	-268373	20-20-3, 20-20+3, 30-2, 30-2+, 30-2-3, 30-20, 30-20+, 30-20-3, 31-1, 31-2, 200-U, 201-2, 202-2, 203-2, 205-02, 206-02, 207-02, 208-02, 209-02, 210-1, 210-01, 301-3, 301-4, 20-2-S, 20-2+S, 20-20-S, 20-20+S, 20-20SP, 30-2-S, 30-2+S, 30-20-S, 30-20+S, 30-20SP, 17-3, 18-2 20-2, 20-20, 20-2+, 20-20+, 20-2-S, 20-20-S, 30-2, 30-20, 30-2+, 30-20+, 30-2-S, 30-20-S	G 1/2"	20,955	210	22	X	-	X	-	-	3		
	621300	-765346	41-5, 42-5	G 1/2"	20,955	300	22	X	-	X	-	-	4		
	621355	-236228	70-4, 112-4, 113-4	G 1/2"	20,955	355	24	X	-	X	-	-	4		
	623260	-113123	12-3, 44-4, 45-4	G 5/8"	22,911	260	24	X	-	X	-	-	5		
	623325	-125263	44-5, 45-5, 113-5, 210-2, 210-3	G 5/8"	22,911	325	24	X	-	X	-	-	5		
	623400	-765353	44-6, 45-6	G 5/8"	22,911	400	24	X	-	X	-	-	7		
	623450	-832796	45-7	G 5/8"	22,911	450	24	X	-	X	-	-	7		
	G 3/4"	626300	-765360	18-3, 20-3, 20-3+, 20-3-3, 20-3-4, 20-3-5, 20-30, 20-30+, 20-30-3, 20-30-4, 20-30-5, 30-3, 30-3+, 30-3-3, 30-3-4, 30-3-5, 201-3, 201-4, 202-3, 202-4, 203-3, 203-4, 205-1, 206-1, 207-1 20-3-S, 20-3+S, 20-30-S, 20-30+S, 20-30SP, 30-3-S, 30-3+S, 30-3SP	G 3/4"	26,441	300	27	X	-	X	-	-	-	5
		626400	-125423	12-4, 205-2, 205-3, 206-2, 206-3, 207-2, 207-3	G 3/4"	26,441	400	27	X	-	X	-	-	5	
626500		-765377		G 3/4"	26,441	500	27	X	-	X	-	-	7		
633400		-765384	18-4, 11-0, 20-4, 46-1, 47-1	G 1"	33,249	400	36	X	-	X	-	-	7		
G 1"	633500	-893452	20-AV, 46-2-A, 47-2-A	G 1"	33,249	500	36	X	-	X	-	-	7		
	633600	-866388	12-6, 12-7	G 1"	33,249	600	36	X	-	X	-	-	8		
	637350	-893469	11-1, 11-2, 30-4, 30-40, 30-5	G 1 1/8"	37,897	350	41	X	-	X	-	-	8		
G 1 1/8"	637500	-893469	15-E	G 1 1/8"	37,897	500	41	X	-	X	-	-	9		
	637600	-169236	18-5, 20-5, 205-4, 207-4	G 1 1/8"	37,897	600	41	X	-	X	-	-	9		

Sicherungsringzangen für Innenringe
ST





729

Circlip pliers, internal
 Pincès pour circlips intérieurs
 Segerring tangen voor inwendige ringen
 Alicates para segmentos de retención interiores
 Pinze per anelli di sicurezza per anelli interni
 Szczypce do wewnętrznych pierścieni zabezpieczających



729T-J0
 729T-J1
 729T-J2
 729T-J3
 729T-J4

729T-J01
 729T-J11
 729T-J21
 729T-J31
 729T-J41





Art.-No.		 mm	 mm		EUR
729T-J0	-139574	3 - 10	135	6	20,90
729T-J1	-545788	10 - 25	135	6	20,90
729T-J2	-545801	19 - 60	180	6	20,90
729T-J3	-545825	40 - 100	225	6	28,00
729T-J4	-545726	85 - 140	320	6	47,00
729T-J01	-139581	3 - 10	135	6	23,60
729T-J11	-545795	10 - 25	135	6	23,60
729T-J21	-545818	19 - 60	180	6	23,60
729T-J31	-545832	40 - 100	225	6	28,80
729T-J41	-545849	85 - 140	320	6	47,00

Sicherungsringzangen-Satz
ST

728

Circlip pliers service set
 Pincès à circlips, jeu pour le service après vente
 Segerring-tangen service-set
 Juego de servicio de alicates para segmentos de retención
 Set di pinze per anelli di sicurezza
 Zestaw serwisowy szczypców do pierścieni zabezpieczających



Art.-No.			Stück pieces			EUR
728T729	-647734	728T-A1, 728T-A11, 728T-A2, 728T-A21, 729T-J1, 729T-J11, 729T-J2, 729T-J21	8	Kunststoff	1	280,60

kurze Hydraulikspindeln
ST

800





Short hydraulic spindles
 Vis hydrauliques courtes
 Korte hydraulische spindels
 Husillos hidráulicos cortos
 Viti idrauliche corte
 Krótkie wrzeciona hydrauliczne



800



801
 802
 804

Art.-No.		 mm	max. t	 mm		EUR
800	-034343	1.1/2"-16(55°;16Gang)	13	10	1	155,30
801	-784446	1.1/2"-16(55°;16Gang)	19	15	1	295,10
802	-784514	M40x1,5	19	20	1	388,40
804	-456787	W1.1/2"-16	19	15	1	332,60



Spindelverlaengerung

ST

800



Spindle extension
Rallonges de vis
Spindelverlengstuk
Alargadera de husillo
Prolunga vite
Przedłużenie wrzeciona

Art.-No.		 L mm		EUR
800-050	-031113	50	1	12,10
800-100	-031298	100	1	13,60
800-150	-031373	150	1	17,30





Mechanische Schlag-Schockspindel

ST

800-626



Mechanical pressure screw
Vis d'extraction mécanique
Mechanische slagspindel
Husillo mecánico
Vite a percussione meccanica
Mechaniczne wrzeciono udarowe

Art.-No.					EUR
800-626	-969980	1.1/2"-16	818-0, 820-0, 844-000, 845-000	1	198,20





Hydraulikspindel-Adapter

ST

800-801



Hydraulic spindle adapter
Adaptateur pour vis hydraulique
Adapter voor hydraulische spindel
Adaptador de husillos hidráulicos
Adattatore per vite idraulica
Adapter wrzeciona hydraulicznego

Art.-No.					EUR
800-801	-923081	G5/8"	129-5, 128-4, 128-5	1	136,40





Abziehvorrichtung mit hydraulischer Spindel

ST

818-0



Pulling device with hydraulic screw
 Extracteur à tirants avec vis hydraulique
 Hulptrekker met hydraulische spindel
 Dispositivo de extracción con hosillo hidráulico
 Dispositivo di estrazione con vite idraulica
 Przyrząd ściągający z wrzecionem hydraulicznym

Art.-No.		 mm	 mm	max. t		EUR
818-0	-173196	240	280	10	1	458,90



Innenauszieher

ST

818-021



Internal extractor
 Extracteur intérieur
 Binnentrekker
 Extractor interior
 Estrattore interno
 Ściągacze wewnętrzne

Art.-No.		∅ mm			EUR
818-021	-757969	30-180	818-0	1	414,10

Zugbolzen und Verlängerungen

ST

818





818-250



818-280

Pulling bolts and extensions
 Tirants et rallonges de tirants
 Trekbouten en verlengstukken
 Tirantes y alargaderas de tirantes
 Tiranti e prolunghe
 Sworzeń pociągowy i przedłużenia

Art.-No.		L mm			EUR
818-250	-173356	250	818-0	1	33,50
818-280	-173431	250	818-0	1	90,30

Hydraulischer Lagerabzieh-Satz

ST

818-100



Hydraulic bearing puller set
 Jeu d'arrache-roulements hydraulique
 Hydraulisch lagertrekker-set
 Juego de extractores hidráulicos de cojinetes
 Set di estrattori idraulici per cuscinetti
 Zestaw hydraulicznych ściągaczy do łożysk

Art.-No.		 mm	 mm	max. t		Stück pieces		EUR
818-100	-717611	280-530	22 - 115	10	L-Boxx	10	1	773,70

Hydraulischer Lagerabzieh-Satz

ST

818-150



Hydraulic bearing puller set
 Jeu d'arrache-roulements hydraulique
 Hydraulisch lagertrekker-set
 Juego de extractores hidráulicos de cojinetes
 Set di estrattori idraulici per cuscinetti
 Zestaw hydraulicznych ściągaczy do łożysk

Art.-No.		 mm	 mm	max. t	Stück pieces			EUR
818-150	-717796	280-780	25 - 155	10	12	L-Boxx	1	941,00

Hydraulischer Lagerab- und Ausziehsatz

ST

818-215



Hydraulic bearing puller and extractor set
 Jeu hydraulique de découleurs et extracteurs de roulements
 Hydraulisch lagerschneider- en trekker set
 Juego de separadores y extractores hidráulicos de cojinetes
 Set di dispositivi estrattori per cuscinetti idraulici
 Zestaw hydraulicznych ściągaczy do łożysk

Art.-No.		 mm	 mm	 mm	max. t	Stück pieces			EUR
818-215	-173271	280-780	25-155	30-180	10	16	Tanos Systemainer	1	1674,50

2-armiger Abzieher mit kurzer Hydraulikspindel

ST

820



2-jaw puller with short hydraulic spindle
 Extracteur à 2 bras avec vis hydraulique courte
 2-armige trekker met hydraulische spindel
 Extractor de 2 brazos con husillo hidráulico corto
 Estrattore a 2 bracci con vite idraulica corta
 2-ramienny ściągacz z krótkim wrzecionem hydraulicznym

 hydraulic
 TECHNOLOGY

Art.-No.		 mm	 mm		EUR
820-0	-173684	225	225	1	505,20

2-armige Universal Abzieher mit selbstzentrierenden Abzughaken und kurzer Hydraulikspindel

ST

844



Universal 2-jaw puller with short hydraulic spindle and self-centering jaws
 Extracteur universel à 2 bras avec vis hydraulique courte et griffes d'extraction autocentreuses
 2-armige universele trekkers met korte hydraulische spindel en zelfcenterende trekhaken
 Extractores universales de 2 brazos con husillo hydr. corto y ganchos de extracción autocentrantes
 Estrattori universali a 2 bracci con griffe autocentranti e vite idraulica corta
 2-ramienny ściągacz uniwersalny z krótkim wrzecionem hydr. i samocentrującymi ramionami

 AUTOGRIP
 TECHNOLOGY hydraulic
 TECHNOLOGY

Art.-No.		 mm	 mm	max. t		EUR
844-1-B	-031601	50 - 100	100	10	1	289,30
844-2-B	-031946	75 - 150	150	10	1	302,00
844-3-B	-032448	75 - 150	250	10	1	332,10
844-4-B	-076091	100 - 200	200	10	1	326,40
844-5-B	-032776	130 - 250	250	10	1	361,70

Ersatzteile für Baugruppe 844/845

ST

844/845

Replacement parts for assembly 844/845
 Pièces de rechange pour module 844/845
 Onderdelen voor serie 844/845
 Piezas de sustitución para el grupo de construcción 844 / 845
 Pezzi di ricambio per le serie 844/845
 Części zamienne do podzespołu 844/845



844-100
844-150
844-200
844-250
844-251

844-000

845-000

Art.-No.		Bezeichnung description			EUR
844-000	-031458	Traverse	844-1-B, 844-2-B, 844-3-B, 844-4-B, 844-5-B	1	63,40
844-020	-135651	Gewindebuchse	844-1-B, 844-2-B, 844-3-B, 844-4-B, 844-5-B, 845-1-B, 845-2-B, 845-3-B, 845-4-B, 845-5-B	1	28,90
844-100	-075919	Abzughaken	844-1-B, 845-1-B	1	54,10
844-150	-031861	Abzughaken	844-2-B, 845-2-B	1	54,10
844-200	-032363	Abzughaken	844-4-B, 845-4-B	1	64,70
844-250	-032103	Abzughaken	844-3-B, 845-3-B	1	51,80
844-251	-032691	Abzughaken	844-5-B, 845-5-B	1	90,30
845-000	-033018	Traverse	845-1-B, 845-2-B, 845-3-B, 845-4-B, 845-5-B	1	72,00

Mechanische Spindeln

ST

844-626



Mechanical pressure screws
Vis d'extraction mécanique
Mechanische spindels
Husillo mecánico
Viti meccaniche
Wrzeciona mechaniczne

Art.-No.					EUR
844-626	-032851	1.1/2"-16	818-0, 820-0, 844-000, 845-000	1	102,60

3-armige Universal Abzieher mit selbstzentrierenden Abzughaken und kurzer Hydraulikspindel

ST

845



Universal 3-jaw puller with short hydraulic spindle and self-centering jaws
Extracteur universel à 3 bras avec vis hydraulique courte et griffes d'extraction autocentreuses
3-armige universele trekkers met korte hydraulische spindel en zelfcenterende trekhaken
Extractores universales de 3 brazos con husillo hidráulico corto y ganchos de extracción autocentrantes
Estrattori universali a 3 bracci con griffe autocentranti e vite idraulica corta
3-ramienny ściągacz uniwersalny z krótkim wrzecionem hydraulicznym i samocentrującymi ramionami



Art.-No.				max. t		EUR
		mm	mm			
845-1-B	-033278	50 - 100	100	10	1	351,10
845-2-B	-033438	75 - 150	150	10	1	376,20
845-3-B	-033681	75 - 150	250	10	1	389,40
845-4-B	-033841	100 - 200	200	10	1	401,70
845-5-B	-034008	130 - 250	250	10	1	414,60

Hydraulischer „4 Abzieher“ - Satz mit selbstzentrierenden Abzughaken

ST

845-150



Hydraulic „4 Puller“ - Set with self-centering pulling arms
Jeu de 4 extracteurs hydrauliques avec griffes d'extraction autocentreuses
Hydraulische „4 trekkers“ set met zelfcenterende trakhaken
Juego de 4 extractores hidráulicos con garras de extracción autocentrante
Set di „4 estrattori“ idraulici con griffe autocentranti
Zestaw 4 ściągaczy hydraulicznych z samocentrującymi ramionami



Art.-No.				max. t	Stück pieces			EUR
		mm	mm					
845-150	-717871	50 - 150	150	10	11	L-Boxx	1	646,90

Hydraulischer „6 Abzieher“ - Satz mit selbstzentrierenden Abzughaken
ST

845-250

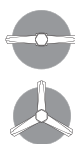

Hydraulic „6 Pullers“ - Set with self-centering pulling arms
 Jeu de 6 extracteurs hydrauliques avec griffes d'extraction autocentreuses
 Hydraulische „6 trekkers“ - set met zelfcentrerende trekhaken
 Juego de 6 extractores hidráulicos con garras de extracción autocentrante
 Set di „6 estrattori“ idraulici con griffe autocentranti
 Zestaw 6 ściągaczy hydraulicznych z samocentrującymi ramionami

Art.-No.		mm	mm	max. t	Stück pieces			EUR
845-250	-717956	75 - 250	250	10	15	L-Boxx	1	932,30

Hydraulischer „10 Abzieher“ - Satz mit selbstzentrierenden Abzughaken
ST

845-851

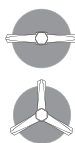

Hydraulic „10 Pullers“ - Set with self-centering pulling arms
 Jeu hydraulique de „10 extracteurs“ avec griffes d'extraction autocentreuses
 Hydraulische „10 trekkers“-set met zelfcentrerende trekhaken
 Juego de „10 extractores“ hidráulicos con garras de extracción autocentrante
 Set di „10 estrattori“ idraulici con griffe autocentranti
 Zestaw 10 ściągaczy hydraulicznych z samocentrującymi ramionami

Art.-No.		mm	mm	max. t	Stück pieces			EUR
845-851	-172854	50 - 250	250	10	21	Tanos Systemainer	1	1228,50

Hydraulischer Universal Abzieh-Satz mit Trennvorrichtung
ST

845-855

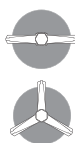

Universal hydraulic puller set with separator
 Jeu d'extracteurs universels hydrauliques avec décolleur
 Hydraulisch universeel trekker set met hulptrekker
 Juego de extractores hidráulicos universales con separadores
 Set di estrattori idraulici universali con separatore
 Uniwersalny zestaw ściągaczy hydraulicznych z urządzeniem rozdzielającym

Art.-No.		mm	mm	mm	mm	max. t	Stück pieces			EUR
845-855	-172939	50 - 250	250	280-780	25 - 155	10	29	Tanos Systemainer	1	2020,20

Hydraulischer Universal Ab- und Ausziehsatz mit selbstzentrierenden Abzughaken mit Trennvorrichtung

ST

845-858

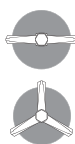

Universal hydraulic puller and extractor set with self-centering jaws with separator
 Jeu d'extracteurs universels hydrauliques avec griffes d'extraction autocentreuses et décolleur
 Hydraulisch universeel trekker met zelfcentrerende haken en hulptrekker
 Juego de extractores y separadores hidráulicos universales con ganchos de extracción autocentrantes con separadores
 Set di estrattori idraulici universali con griffe autocentranti e separatore
 Uniwersalny zestaw ściągaczy hydr. z samocentrującymi ramionami i urządzeniem rozdzielającym

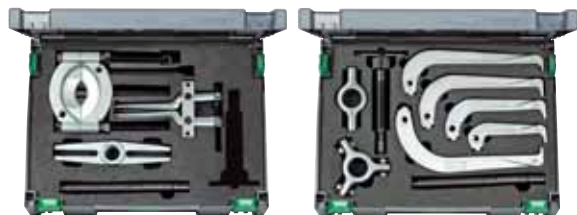

Art.-No.	4021176	mm	mm	mm	mm	mm	max. t	Stück pieces			EUR
845-858	-173011	50-250	250	280-780	25-155	30 - 180	10	30	Tanos System	1	2436,00

Universal-Pressrahmen für Silentbuchsen

ST

880

Universal press frame for silent bushings
 Bâti de presse universel pour douilles silencieuses
 Unierspersraam voor silentbussen
 Bastidor universal a presión para casquillos silenciosos
 Telaio di pressaggio universale
 Uniwersalna rama płytowa do tulejek cichobieżnych



Art.-No.	4021176	max. t	mit with		EUR
880-800	-433689	10	800	1	482,80
880-801	-433696	15	801	1	607,70
880-802	-433702	20	802	1	709,00

Druckstücksätze für Universal Pressrahmen

ST

880

Pressure piece kits for universal press frame
 Patins de serrage pour huisserie à presse
 Set drukstukken voor universeel persraam
 Juegos de piezas de presión de husillos para bastidores universales a presión
 Set di pressori per telaio di pressaggio
 Zestawy elementów dociskowych do uniwersalnej ramy płytowej





Art.-No.	4021176	für for	Stück pieces		EUR
880-114	-433610	DB W124; 201; 129	3	1	162,30
880-137	-433627	BMW (3er); E36	4	1	290,40
880-144	-433634	VW T4 (92)	4	1	337,70
880-147	-433658	VW LT; DB Sprinter	4	1	641,60

Druck- und Zughülsen-Satz
ST

880



Pressure and pulling sleeve kit
 Set à depresser et detirer douilles
 Set druk- en trekhuizen
 Juego de manguito de tracción y de presión
 Set di ghiera di pressione e di trazione
 Zestaw tulejek dociskowych i pociągowych





Art.-No.		für for	Stück pieces			EUR
880-400	-433672	PKW + LKW	28	Kunststoff	1	945,40

Unfallschutz-Planen für Abzieharbeiten
ST

UFP



Protective tarps for extraction jobs
 Toiles de protection contre les accidents pendant les travaux d'extraction
 Veiligheids-beschermhoezen voor trekwerkzaamheden
 Cubiertas de lona para proteger contra accidentes
 Piano di protezione per operazioni di estrazione
 Plandeki ochronne do prac przy ściąganiu



Art.-No.		 mm	 mm		EUR
UFP-1	-445118	1100	500	1	232,30
UFP-2	-445293	1500	670	1	260,90
UFP-3	-445378	4000	1300	1	1078,10

Dreh-Display
ST

EVLW-D



Rotary display
 Écran de rotation
 Draaibare display
 Caballete giratorio
 Display ruotante
 Wyświetlacz obrotowy

Art.-No.			EUR
EVLW-D-1	-314377	EVLW-10, EVLW-20, EVLW-30	147,00
EVLW-D-2	-314384	EVLW-10, EVLW-20, EVLW-30	147,00



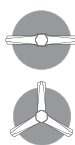

Verkaufswand Industrie

ST

EVLW-10



Merchandiser, industrial pullers
 Présentoir de vente, outillage pour l'industrie
 Verkoopwand, industrie-gereedschap
 Expositor de venta, herramientas para industria
 Display di vendita Industria
 Ścianka z narzędziami do przemysłu

Art.-No.		 mm	 mm	
EVLW-10	-056239	1000	2200	
EVLW-10-DEMO	-222658	1000	2200	



EVLW-10



EVLW-10-DEMO



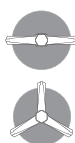

Verkaufswand Automotive

ST

EVLW-20



Merchandiser, automotiv pullers
 Présentoir de vente, outillage pour l'automobile
 Verkoopwand, automobil-gereedschap
 Expositor de venta, herramientas para automoviles
 Display di vendita Automotive
 Ścianka z narzędziami do przemysłu samochodowego

Art.-No.		 mm	 mm	
EVLW-20	-056246	1000	2200	
EVLW-20-DEMO	-222665	1000	2200	



EVLW-20



EVLW-20-DEMO



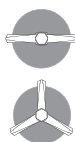

Verkaufswand Kugellager (SKF)

ST

EVLW-30



Merchandiser, roller bearing tools
 Présentoir de vente, arrache-roulements
 Verkoopwand, kogellager-trekkers
 Expositor de venta, herramientas para cojinetes de bolas
 Display di vendita cuscinetti a sfera (SKF)
 Ścianka z narzędziami do łożysk tocznych

Art.-No.		 mm	 mm	
EVLW-30	-056253	1000	2200	
EVLW-30-DEMO	-222672	1000	2200	



EVLW-30







EVLW-30-DEMO

Wandtafel, unbestückt
ST

WT-000



Wall panel, blank
 Panneau mural pas équipé
 Wandbord, leeg
 Panel mural sin equipar
 Pannello a muro, non attrezzato
 Tablica ścienna, bez wyposażenia





Art.-No.		 mm	 mm		EUR
WT-000	-890550	500	1000	1	152,40

Universal Abzieher „Industrie-Satz“ auf Wandtafel
ST

WT-002



Universal pullers „Industrial set“ on wall panel
 Extracteurs universels „Jeu industriel“ sur panneau mural
 Universele trekkers „Industrie set“ op wandbord
 Extractores universales „Juego para la industria“ en panel mural
 Estrattore universale „Set per l'industria“ su pannello a muro
 Ściągacze uniwersalne „Zestaw przemysłowy“ na tablicy ściennej





Art.-No.		 mm	 mm	max. t	Stück pieces		EUR
WT-002	-890567	90 - 200	100 - 150	7	11	1	1345,90

Universal Abzieher „Industrie-Satz“ auf Wandtafel
ST

WT-003



Universal pullers „Industrial set“ on wall panel
 Extracteurs universels „Jeu industriel“ sur panneau mural
 Universele trekkers „Industrie set“ op wandbord
 Extractores universales „Juego para la industria“ en panel mural
 Estrattore universale „Set per l'industria“ su pannello a muro
 Ściągacze uniwersalne „Zestaw przemysłowy“ na tablicy ściennej

Art.-No.		 mm	 mm	Stück pieces		EUR
WT-003	-890574	90 - 200	100 - 150	10	1	1087,70



Universal Werkzeuge PKW „Basis-Satz“ auf Wandtafel

ST

WT-004

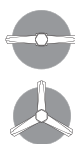

Universal passenger-car tools „Basic set“ on wall panel
 Outillage universel voitures „Jeu de base“ sur panneau mural
 Universeel gereedschap personenwagens „Basis set“ op wandbord
 Herramientas universales para automóviles „Juego básico“ en panel mural
 Utensili universali per autovetture „Set di base“ su pannello a muro
 Uniwersalne narzędzia do samochodów osobowych „Zestaw podstawowy“ na tablicy ściennej



Art.-No.						Stück pieces		EUR
	40211761	mm	mm	mm	mm			
WT-004	-890581	90	100	18 - 29	10-18	12	1	878,90

Spezial Werkzeuge PKW auf Wandtafel

ST

WT-006



Special-purpose passenger-car tools on wall panel
 Outillage spécial voitures sur panneau mural
 Speciaal gereedschap personenwagens op wandbord
 Herramientas especiales para automóviles en panel mural
 Utensili speciali per autovetture su pannello a muro
 Specjalne narzędzia do samochodów osobowych na tablicy ściennej



Art.-No.						Stück pieces		EUR
	40211761	mm	mm	mm	mm			
WT-006	-890598	95 - 200	100 - 170	18 - 22	7-22	11	1	1917,10

Universal Werkzeuge LKW „Basis-Satz“ auf Wandtafel

ST

WT-008

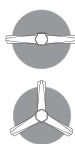

Universal truck tools „Basic set“ on wall panel
 Outillage universel camions „Jeu de base“ sur panneau mural
 Universeel gereedschap vrachtwagens „Basis set“ op wandbord
 Herramientas universales para camiones „Juego básico“ en panel mural
 Utensili universali per autocarri „Set di base“ su pannello a muro
 Uniwersalne narzędzia do samochodów ciężarowych „Zestaw podstawowy“ na tablicy ściennej



Art.-No.					max. t	Stück pieces		EUR
	40211761	mm	mm	mm				
WT-008	-890604	200	150 - 200	22 - 115	10	11	1	1381,40

Universal Werkzeuge „LKW Fahrwerk“ auf Wandtafel
ST

WT-009



Universal „truck-chassis“ tools on wall panel
 Outillage universel „Châssis de camions“ sur panneau mural
 Universeel gereedschap „vrachtwagen chassis“ op wandbord
 Herramientas universales „Bastidor de camiones“ en panel mural
 Utensili universali „Carrello autocarri“ su pannello a muro
 Uniwersalne narzędzia „Podwozie samochodów ciężarowych“ na tablicy ściennej



Art.-No.						max. t	Stück pieces		EUR
		mm	mm	mm	mm				
WT-009	-890611	150 - 350	150	30 - 34	22-36	7 + 10	14	1	2016,00

Abziehwerkzeuge Schwere LKW „Basis-Satz“ auf Wandtafel
ST

WT-010



Pulling devices for heavy trucks „Basic set“ on wall panel
 Outillage d'extraction poids lourds „Jeu de base“ sur panneau mural
 Trekgereedschap zware vrachtwagens „Basis set“ op wandbord
 Herramientas de extractoras para camiones pesados „Juego básico“ en panel mural
 Utensili per estrazione per autocarri pesanti „Set di base“ su pannello a muro
 Narzędzia ściągające do ciężkich samochodów ciężarowych „Zestaw podstawowy“ na tablicy ściennej



Art.-No.						max. t	Stück pieces		EUR
		mm	mm	mm	mm				
WT-010	-890628	250	200	22 - 115	36 - 40	8	10	1	2395,10

Universal Werkzeuge „PKW Lenkung“ auf Wandtafel
ST

WT-014



Universal passenger-car tools „Steering“ on wall panel
 Outillage universel „Direction voitures“ sur panneau mural
 Universeel gereedschap „personenwagens stuurinrichting“ op wandbord
 Herramientas universales „Dirección de automóviles“ en panel mural
 Utensili universali per „Sterzo autovetture“ su pannello a muro
 Uniwersalne narzędzia „Układ kierowniczy samochodów osobowych“ na tablicy ściennej



Art.-No.						max. t	Stück pieces		EUR
		mm	mm	mm	mm				
WT-014	-890635	120	100	12 - 75	18 - 30	10	10	1	1323,90

Universal Werkzeuge „Allgemeine Instandsetzung“ auf Wandtafel

ST

WT-016



Universal tools „General engineering“ on wall panel
 Outillage universel „Réparation générale“ sur panneau mural
 Universeel gereedschap „algemeen onderhoud“ op wandbord
 Herramientas universales „Reparaciones en general“ en panel mural
 Utensili universali per „Manutenzione generale“ su pannello a muro
 Uniwersalne narzędzia „Naprawy ogólne“ na tablicy ściennej



Art.-No.						max. t	Stück pieces		EUR
	4021176	mm	mm	mm	mm				
WT-016	-893483	200	150-300	22-115	12-46	10	14	1	1777,10

Spezial Werkzeuge PKW auf Wandtafel

ST

WT-030

Special-purpose passenger-car tools on wall panel
 Outillage spécial voitures sur panneau mural
 Speciaal gereedschap personenwagens op wandbord
 Herramientas especiales para automóviles en panel mural
 Utensili speciali per autovetture su pannello a muro
 Specjalne narzędzia do samochodów osobowych na tablicy ściennej

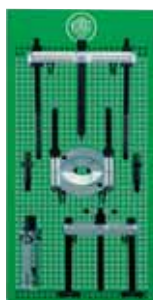

Art.-No.				Stück pieces		EUR
	4021176	mm	mm			
WT-030	-893490	25 - 155	56 - 110	6	1	1314,30

Spezial Werkzeug „SAF-Achsen“ auf Wandtafel

ST

WT-031

Special-purpose tools „SAF axles“ on wall panel
 Outillage spécial „Essieux SAF“ sur panneau mural
 Speciaal gereedschap „SAF assen“ op wandbord
 Herramientas especiales „Ejes SAF“ en panel mural
 Utensili speciali per „Assi SAF“ su pannello a muro
 Narzędzie specjalne „Osie SAF“ na tablicy ściennej



Art.-No.				Stück pieces		EUR
	4021176	mm	mm			
WT-031	-914584	134 - 350	380	5	1	1009,40

Universal-Abzieher-Satz auf Lochtafel
ST

WT-50

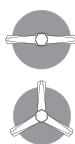

Universal puller set on wall panel
 Jeu d'extracteurs universels sur panneau
 Universeel trekker-set op wandbord
 Juego de extractores universales en panel mural
 Set di estrattori universali su piastre perforate
 Zestaw ściągacza uniwersalnego na tablicy z otworami



Art.-No.		 mm	 mm	 mm	max. t		EUR
WT-50	-951114	0 - 200	100 - 300	22 - 115	4,5-6	1	1236,00

Universal-Abzieher-Satz auf Lochtafel
ST

30-20-T



Universal puller set on wall panel
 Jeu d'extracteurs universels sur panneau
 Universeel trekker-set op wandbord
 Juego de extractores universales en panel mural
 Set di estrattori universali su piastre perforate
 Zestaw ściągacza uniwersalnego na tablicy z otworami



Art.-No.		 mm	 mm	 mm	Stück pieces		EUR
30-20-T	-875717	0 - 200	100 - 300	22 - 115	14	1	1058,80

Universal Abziehsatz auf Lochplatte
ST

220-T

Universal puller set on perforated plate
 Jeu universel d'extracteurs sur plateau perforé
 Universeel trekkerset op wandbord
 Juego universal de extractores en placa perforada
 Set di estrattori universali su piastra perforata
 Zestaw ściągaczy uniwersalnych na płycie z otworami



Art.-No.		 mm	 mm	Stück pieces		EUR
220-T	-778759	130 - 450	80 - 400	4	1	1091,80



hydraulic
TECHNOLOGY

**Hydraulische Werkzeuge
für Pumpenantrieb
Hydraulic cylinder tools for pump drive**

3-armiger Kombi-Abzieher mit schwenkbaren Abzughaken (ohne hydraulischen Druckzylinder für Pumpenantrieb)
HY

Y-208



3-jaw combination puller with swiveling jaws (without hydraulic cylinder for pump drive)
 3-jaw combination puller with swiveling double-end jaws (without hydr. cylinder for pump drive)
 3-armige combi trekker met zwenkbare trekhaken (zonder hydr. drukcilinders voor pompbediening)
 Extractor combinados de 3 brazos con ganchos de extracción giratorios (sin cilindros de presión hydr. para accionamiento de bomba)
 3-ramienne ściągaćze kombinowane z ramionami rozwieralnymi (bez cylindra hydr. w połączeniu z pompą)



Art.-No.		 mm	 mm		EUR
Y05-208	-172366	250	215	1	260,30
Y10-208	-172441	500	500	1	650,10

Hydraulischer 3-armiger Kombi-Abzieher mit schwenkbaren Abzughaken, mit hydraulischem Druckzylinder für Pumpenantrieb
HY

Y-208



Hydraulic 3-jaw combination puller with swiveling jaws, with hydraulic cylinder for pump drive
 Extracteur combiné hydr. à 3 bras avec griffes d'extraction articulées, avec vérin hydr. pour groupe motopompe
 Hydr. 3-armige trekker met zwenkbare trekhaken, met hydr. drukcilinders voor pompbediening
 Extractor hydr. combinados de 3 brazos con ganchos de extracción giratorios, con cilindros de presión hydr. para accionamiento de bomba
 3-ramienne ściągaćze kombinowane z ramionami rozwieralnymi z siłownikiem hydr. w połączeniu z pompą



Art.-No.		 mm	 mm	max. t	 mm		EUR
Y08-208	-461774	250	215	5	125	1	796,10
Y18-208	-461699	500	500	10	250	1	1332,80

Hydraulische Druckzylinder mit Kragengewinde
HY

YRE

Hydraulic cylinder rams with collar threads
 Vérins hydrauliques à collet fileté
 Hydraulische drukcilinders met buitendraad
 Cilindros de presión hidráulicos con rosca de collarín
 Cilindri prementi idraulici con collare filettato
 Hydrauliczne cylindry dociskowe z gwintem kołnierzowym

 YRE-050
YRE-101

YRE-102



Art.-No.		max. t	 mm		EUR
YRE-050	-046551	5	125	1	532,30
YRE-101	-870927	10	250	1	818,10
YRE-102	-160660	10	100	1	1202,20





Abziehvorrichtung (ohne hydraulischen Hohlkolbenzylinder für Pumpenantrieb)

HY

Y-180



Push/pulling device (without hydraulic hollow ram for pump drive)
 Dispositif d'extraction (sans vérin hydraulique à piston creux pour groupe motopompe)
 Hulptrekkers (zonder hydraulische holle-plunjer cylinder voor pompbediening)
 Dispositivos extractores (sin cilindro de émbolo hueco hidr. para accionamiento de bomba)
 Ściągacze (bez cylindra hydraulicznego w połączeniu z pompą)

Art.-No.		 mm	 mm	max. t		EUR
Y20-180	-036323	135 - 300	300	20	1	728,50
Y30-180	-037313	180 - 420	520	30	1	1214,20
Y50-180	-038303	180 - 420	50	50	1	3085,40





Hydraulische Abziehvorrichtung mit hydraulischem Hohlkolbenzylinder für Pumpenantrieb

HY

Y-180



Hydraulic push/pulling device with hydraulic hollow ram for pump drive
 Dispositif d'extraction hydr. avec vérin hydraulique à piston creux pour groupe motopompe
 Hydraulische hulptrekkers met hydraulische holle-plunjer cylinder voor pompbediening
 Dispositivos extractores hidráulico con cilindros de presión hidr. para accionamiento de bomba
 Dispositivo di estrazione idraulica a 2 bracci con azionamento a pompa
 Hydrauliczny ściągacze z siłownikiem hydraulicznym w połączeniu z pompą

Art.-No.		 mm	 mm	max. t		EUR
Y28-180	-036408	135 - 300	300	20	1	2554,00
Y38-180	-037498	180 - 420	520	30	1	3560,00
Y58-180	-038488	180 - 420	520	50	1	7292,60

Zubehör für Hydraulische Abziehvorrchtungen
HY

Y-180

Accessories for hydraulic pulling devices
 Accessoire pour dispositifs d'extraction hydrauliques
 Toebehoren voor hydraulische hulptrekkers
 Accesorios para dispositivos extractores hidráulicos
 Accessori per dispositivi di estrazione idraulici
 Akcesoria do ściągaczy hydraulicznych

 Y218-03
 Y318-03
 Y518-03

 Y218-06-P
 Y218-07-P
 Y218-08-P
 Y318-36-P
 Y318-37-P
 Y318-38-P
 Y518-07-P
 Y518-08-P

 Y218-33
 Y318-33
 Y518-33

Art.-No.		Bezeichnung description	max. t			EUR
Y218-03	-039706	Traverse	20	Y20-180, Y28-180	1	383,50
Y218-06-P	-056420	Paar Zugbolzen 240 mm	20	Y20-180, Y28-180	1	128,40
Y218-07-P	-056437	Paar Zugbolzen 420 mm	20	Y20-180, Y28-180	1	164,40
Y218-08-P	-056444	Paar Zugbolzen 570 mm	20	Y20-180, Y28-180	1	208,20
Y218-09-P	-218095	Paar Stützmuttern für Zugbolzen	20	Y20-180, Y28-180	1	91,50
Y218-12-P	-097157	Paar Zugbolzen 115 mm	20	Y20-180, Y28-180	1	109,60
Y218-31-P	-218316	Paar Verbinder für Zugbolzen	20	Y20-180, Y28-180	1	84,40
Y218-33	-040771	Schnellverstellmutter	20	Y20-180, Y28-180	1	82,40
Y318-03	-041686	Traverse (Joch)	30	Y30-180, Y38-180	1	522,10
Y318-04	-318047	Satz Befestigungsmaterial für 1 Paar Zugbolzen	30	Y30-180, Y38-180	1	100,80
Y318-36-P	-056338	Paar Zugbolzen 205 mm	30	Y30-180, Y38-180	1	253,80
Y318-37-P	-305863	Paar Zugbolzen 460 mm	30	Y30-180, Y38-180	1	352,80
Y318-38-P	-056345	Paar Zugbolzen 710 mm	30	Y30-180, Y38-180	1	606,40
Y318-39-P	-318399	Paar Stützmuttern für Zugbolzen	30	Y30-180, Y38-180	1	202,50
Y318-41-P	-318412	Paar Verbinder für Zugbolzen	30	Y30-180, Y38-180	1	97,50
Y318-33	-042188	Schnellverstellmutter	30	Y30-180, Y38-180	1	140,90
Y518-03	-043826	Traverse (Joch)	50	Y50-180, Y58-180	1	1496,90
Y518-07-P	-056468	Paar Zugbolzen 610 mm	50	Y50-180, Y58-180	1	858,30
Y518-08-P	-056475	Paar Zugbolzen 865 mm	50	Y50-180, Y58-180	1	685,00
Y518-09-P	-518096	Paar Stützmuttern für Zugbolzen	50	Y50-180, Y58-180	1	446,20
Y518-31-P	-518317	Paar Verbinder für Zugbolzen	50	Y50-180, Y58-180	1	261,70
Y518-33	-044571	Schnellverstellmutter	50	Y50-180, Y58-180	1	208,80

2-armiger Abzieher mit schwenkbaren Abzughaken (ohne hydraulischen Hohlkolbenzylinder für Pumpenantrieb)
HY

Y-205



2-jaw puller with swiveling jaws (without hydraulic hollow ram for pump drive)
 Extracteur à 2 bras avec griffes d'extraction articulées (sans vérin hydr. à piston creux pour groupe motopompe)
 2-armige trekker met zwenkbare trekhaken (zonder hydr. holle-plunjer cylinder voor pompbediening)
 Extractor de 2 brazos con ganchos de extracción giratorios (sin cilindro de émbolo hueco hydr. para accionamiento de bomba)
 Dispositivo di estrazione idraulico a 2 bracci con azionamento a pompa
 2-ramienne ściągacze z ramionami rozwieralnymi (bez cylindra hydr. w połączeniu z pompą)



Art.-No.				max. t		EUR
		mm	mm			
Y20-205	-035906	420	300	20	1	556,90
Y30-205	-036996	700	520	30	1	1147,10
Y50-205	-037986	1000	700	50	1	2151,20

Hydraulischer 2-armiger Abzieher mit schwenkbaren Abzughaken, mit hydraulischem Hohlkolbenzylinder für Pumpenantrieb

HY

Y-205



Hydraulic 2-jaw puller with swiveling jaws, with hydraulic hollow ram for pump drive
 Extracteur hydr. à 2 bras avec griffes d'extraction articulées, avec vérin hydr. à piston creux pour groupe motopompe
 Hydr. 2-armige trekker met zwenkbare trekhaken, met hydr. e holle-plunjer cylinder voor pompbediening
 Extractor hidr. de 2 brazos con ganchos de extracción giratorios, con cilindro de émbolo hueco hidr. para accionamiento de bomba
 Estrattore idraulico a 2 bracci con griffe scorrevoli e azionamento a pompa
 Hydr. 2-ramienne ściągacze z ramionami rozwieralnymi z siłownikiem hydr. w połączeniu z pompą



Art.-No.				max. t	EUR
		mm	mm		
Y28-205	-036088	420	300	20	1823,60
Y38-205	-037078	700	520	30	2738,50
Y58-205	-038068	1000	700	50	5531,50

3-armiger Abzieher mit schwenkbaren Abzughaken (ohne hydraulischen Hohlkolbenzylinder für Pumpenantrieb)

HY

Y-206



3-jaw puller with swiveling jaws (without hydraulic hollow ram for pump drive)
 Extracteur à 3 bras avec griffes d'extraction articulées (sans vérin hydr. à piston creux pour groupe motopompe)
 3-armige trekker met zwenkbare trekhaken (zonder hydr. holle-plunjer cylinder voor pompbediening)
 Extractor de 3 brazos con ganchos de extracción giratorios (sin cilindro de émbolo hueco hidr. para accionamiento de bomba)
 Estrattore idraulico a 3 bracci con griffe scorrevoli per azionamento a pompa
 3-ramienne ściągacze z ramionami rozwieralnymi (bez cylindra hydr. w połączeniu z pompą)



Art.-No.				max. t		EUR
		mm	mm			
Y20-206	-036163	500	300	20	1	867,30
Y30-206	-037153	900	520	30	1	1802,20
Y50-206	-038143	1200	700	50	1	3357,00

Hydraulischer 3-armiger Abzieher mit schwenkbaren Abzughaken, mit hydraulischem Hohlkolbenzylinder für Pumpenantrieb

HY

Y-206



Hydraulic 3-jaw puller with swiveling jaws, with hydraulic hollow ram for pump drive
 Extracteur hydraulique à 3 bras avec griffes d'extraction articulées, avec vérin hydr. à piston creux pour groupe motopompe
 Hydr. 3-armige trekker met zwenkbare trekhaken, met hydr. holle-plunjer cylinder voor pompbediening
 Extractor hidr. de 3 brazos con cilindro de émbolo hueco hidr. para accionamiento de bomba
 Dispositivo di estrazione idraulica a 3 bracci con griffe scorrevoli e azionamento a pompa
 Hydr. 3-ramienne ściągacze z ramionami rozwieralnymi z siłownikiem hydr. w połączeniu z pompą



Art.-No.				max. t		EUR
		mm	mm			
Y28-206	-036248	500	300	20	1	2373,20
Y38-206	-037238	900	520	30	1	3649,20
Y58-206	-038228	1200	700	50	1	7028,00

Zubehör für hydraulische Abzieher

HY

Y-205/206

Accessories for hydraulic pullers
 Accessoires pour extracteurs hydrauliques
 Toebehoren voor hydraulische trekkers
 Accesorios para extractores hidráulicos
 Accessori per estrattori idraulici
 Akcesoria do ościągaczy hydraulicznych

 Y205-00
Y305-00
Y505-00

 Y205-20
Y305-20
Y505-20

 Y206-30
Y306-30
Y506-30

Art.-No.		Bezeichnung description	max. t			EUR
Y205-00	-273759	Abzughaken mit Laschen, Schrauben und Muttern	20	Y20-205, Y20-206, Y28-205, Y28-206	1	186,20
Y205-20	-038976	2-Arm Traverse	20	Y20-205, Y20-206, Y28-205, Y28-206	1	171,10
Y206-30	-039478	3-Arm Traverse	20	Y20-205, Y20-206, Y28-205, Y28-206	1	456,50
Y305-00	-273834	Abzughaken mit Laschen, Schrauben und Muttern	30	Y30-205, Y30-206, Y38-205, Y38-206	1	447,10
Y305-20	-040931	2-Arm Traverse	30	Y30-205, Y30-206, Y38-205, Y38-206	1	253,80
Y306-30	-041433	3-Arm Traverse	30	Y30-205, Y30-206, Y38-205, Y38-206	1	461,80
Y505-00	-273919	Abzughaken mit Laschen, Schrauben und Muttern	50	Y50-205, Y50-206, Y58-205, Y58-206	1	815,80
Y505-20	-042911	2-Arm Traverse	50	Y50-205, Y50-206, Y58-205, Y58-206	1	520,40
Y506-30	-043413	3-Arm Traverse	50	Y50-205, Y50-206, Y58-205, Y58-206	1	909,40

Hydraulische Hohlkolbenzylinder

HY

YRH

Hydraulic hollow rams
 Vérin hydraulique à piston creux
 Hydraulische holle-plunjer cylinder
 Cilindros de émbolo hueco hidráulicos
 Cilindri idraulici a pistone cavo
 Hydrauliczne drążone cylindry tłokowe



hydraulic TECHNOLOGY

Art.-No.		 mm	max. t		EUR
YRH-202	-046711	50	20	1	1109,00
YRH-206	-870934	150	20	1	1902,90
YRH-302	-046896	63	30	1	1224,40
YRH-603	-046971	75	50	1	2597,80

Zubehör für Hohlkolbenzylinder

HY

Y-10/11

Accessories for hollow rams
 Accessoire pour vérins à piston creux
 Toebehoren voor cylinders met holle plunjer
 Accesorios para cilindros de émbolo hueco
 Accessori per cilindro idraulico a pistone cavo
 Akcesoria do drążonych cylindrów tłokowych

 Y218-10
Y318-10
Y518-10

 Y218-11
Y318-11
Y518-11

Art.-No.		Bezeichnung description	max. t			EUR
Y218-10	-040368	Handkurbel	20	YRH-202	1	34,90
Y218-11	-040443	Mittelspindel	20	YRH-202	1	109,70
Y318-10	-041761	Handkurbel	30	YRH-302	1	46,10
Y318-11	-041846	Mittelspindel	30	YRH-302	1	383,50
Y518-10	-044243	Handkurbel	50	YRH-603	1	65,50
Y518-11	-044328	Mittelspindel	50	YRH-603	1	529,50



Druckstücksätze für Achsbohrungen

HY

Y-18-17



Step plate adapter sets for center-bored parts
 Jeux d'embouts de pression de vis pour alésages axiaux
 Spindelstukken-sets voor asboringen
 Juego de piezas de presión de husillos para taladros de eje
 Set di pressori per fori degli assi
 Zestawy elementów dociskowych do nawiercania osi

Art.-No.		Ø mm	Bezeichnung description		EUR
Y-18-17	-235078	20-62	12-teilig	1	625,40
Y-19-17	-235153	33-81	12-teilig	1	988,70
Y-20-17	-235238	55-88	6-teilig	1	636,00
Y-01-17	-233173	20-23	einzel	1	28,40
Y-02-17	-233258	23-26	einzel	1	34,50
Y-03-17	-233333	26-30	einzel	1	40,40
Y-04-17	-233418	29-33	einzel	1	45,80
Y-05-17	-233586	33-39	einzel	1	51,60
Y-06-17	-233661	36-42	einzel	1	58,10
Y-07-17	-233746	39-46	einzel	1	63,50
Y-08-17	-233821	42-48	einzel	1	68,70
Y-09-17	-233906	45-52	einzel	1	74,70
Y-10-17	-234163	49-58	einzel	1	77,40
Y-11-17	-234248	51-62	einzel	1	85,40
Y-12-17	-234408	55-65	einzel	1	91,20
Y-13-17	-234576	58-68	einzel	1	96,80
Y-14-17	-234651	61-71	einzel	1	102,90
Y-15-17	-234736	65-74	einzel	1	108,30
Y-16-17	-234811	71-81	einzel	1	113,40
Y-17-17	-234996	77-88	einzel	1	124,90

Druckstücke für Hohlkolbenzylinder

HY

YDB

Pressure pads for hollow rams
 Embouts de pression pour vérins à piston creux
 Drukstukken voor cylinders met holle plunjer
 Piezas de presión para cilindros de émbolo hueco
 Pressori per cilindri a pistone cavo
 Elementy dociskowe do drążonych cylindrów tłokowych





YDB



YDG



YDM

Art.-No.		max. t		EUR
YDB-27E	-400223	20	1	72,20
YDB-33E	-400308	30	1	74,20
YDB-55E	-400483	50	1	91,60
YDG-20E	-399091	20	1	76,10
YDG-30E	-399176	30	1	78,70
YDG-50E	-399251	50	1	121,90
YDM-20E	-414183	20	1	77,20
YDM-30E	-414268	30	1	83,60
YDM-50E	-414343	50	1	129,10

Hydraulischer Universal Abzieh-Satz
HY

Y-200



Universal hydraulic gear and bearing puller set
 Jeu hydraulique d'arrache-roues et arrache-roulement universels
 Universeel hydraulische trekker set
 Juego de extractores hidráulicos universales
 Set di estrattori universali
 Hydrauliczny uniwersalny zestaw ściągający



Art.-No.		mm	mm	mm	max. t		EUR
Y28-200	-870828	500	300	25 - 155	20	1	6517,10
Y38-300	-870835	900	520	30 - 250	30	1	9125,20
Y58-500	-870842	1200	700	75 - 330	50	1	15516,00

Hydraulische Abziehvorrichtungs-Sätze
HY

Y-218

Hydraulic push/pull device sets
 Jeuf de dispositifs hydrauliques d'extraction
 Hydraulische hulptrekker sets
 Juegos de dispositivos extractores hidráulicos
 Set di dispositivi di estrazione idraulici
 Zestawy hydraulicznych narzędzi ściągających



Art.-No.		mm	mm	mm	max. t		EUR
Y28-218	-036651	140	30 - 180	25 - 155	20	1	4563,60
Y38-318	-037641	150	75 - 230	30 - 250	30	1	7060,40
Y58-518	-038891	150	75 - 230	75 - 330	50	1	11360,60

Hydraulische Radabziehsätze
HY

Y-256

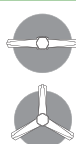

Hydraulic wheel-puller sets
 Jeux d'arrache-roues hydrauliques
 Hydraulische wieltrek-sets
 Juegos de extractores hidráulicos de ruedas
 Set di estrazione idraulici per pneumatici
 Zestawy hydraulicznych ściągaczy kół



Art.-No.		mm	mm	max. t		EUR
Y28-256	-036811	500	300	20	1	3725,70
Y38-356	-037801	900	520	30	1	5367,10
Y58-556	-038631	1200	700	50	1	8969,30

Belastungswerte: / load levels:
Folgende Werte müssen eingehalten werden: / the following limits must be adhered to:

Nennkraft / rating	(10 kn = 1 Mp = 1t)	20 t	30 t	50 t
Abzieher 3-armig / 3-arm puller	max. zulässige Belastung	20 t	30 t	50 t
Abzieher 2-armig / 2-arm puller		15 t	25 t	45 t
Abziehvorrichtung nur mit Zugbolzen / extractor with pulling bolt only		15 t	25 t	35 t
Abziehvorrichtung mit Trennvorrichtung / extractor with separator		15 t	20 t	30 t
Abziehvorrichtung mit Innenauszieher / extractor with internal puller		10 t	20 t	25 t

Pumpenhydraulische Mutternsprenger im Koffer

HY

Y-57

Pump-hydraulic nut splitter, in case
 Casse-écrous hydrauliques à pompe en coffret
 Hydraulische moerensplijters met pompbediening in koffer
 Tronzatuercas hidráulico de bomba en maletín
 Spaccadadi idraulici a pompa in valigetta
 Hydrauliczny przecinak do nakrętek w walizce



Y-5724M
 Y-5732M
 Y-5741M
 Y-5750M
 Y-5760M



Y-57-24
 Y-57-32
 Y-57-41
 Y-57-50
 Y-57-60

Art.-No.		mm				EUR
Y-57-24	-870675	24-32	Y-5724M	Metall	1	2978,40
Y-57-32	-870682	32-41	Y-5732M	Metall	1	3805,80
Y-57-41	-870699	41-50	Y-5741M	Metall	1	4963,70
Y-57-50	-870705	50-60	Y-5750M	Metall	1	7147,50
Y-57-60	-870712	60-75	Y-5760M	Metall	1	12574,00
Y-5724M	-803741	Sprengmeißel	Y-57-24	-	1	211,50
Y-5732M	-803826	Sprengmeißel	Y-57-32	-	1	229,00
Y-5741M	-803901	Sprengmeißel	Y-57-41	-	1	252,60
Y-5750M	-804083	Sprengmeißel	Y-57-50	-	1	286,80
Y-5760M	-804168	Sprengmeißel	Y-57-60	-	1	490,70

Hydraulisches Radnabenabziehwerkzeug, speziell für Niederflrbusse: MB Citaro, MAN, Neoplan

HY

Y-60-100

Hydraulic wheel puller for low-floor bus: MB Citaro, MAN, Neoplan
 Extracteur moyeu hydraulique pour le bus à plancher bas: MB Citaro, MAN, Neoplan
 Hydraulische wielnaaftrekgereedschap, voor lagevloerbus: MB Citaro, MAN, Neoplan
 Herramientas extractoras hidráulico para cubos, para autobuses: MB Citaro, MAN, Neoplan
 Utensili per l'estrazione delle ruote
 Narzędzia do ściągania piast kół hydr., dla autobusów niskopodłogowych: MB Citaro, MAN, Neoplan



Art.-No.			max. t		Stück pieces			EUR
Y-60-100	-356780	M16; M18; M20	30	YHP-321	22	L-Boxx	1	2477,50

TIPP:

Nicht im Lieferumfang enthalten sind die hydraulische Pumpe **YHP-320** und der Schlauch **YF-200**. **Diese werden jedoch zum Betätigen des Abziehers benötigt!**

Trennvorrichtungen für hydraulische Abziehvorrchtungen

HY

Y-15

Separators for hydraulic push/pull devices
 Décolleurs pour utilisation avec dispositifs hydrauliques
 Mestrekkers voor gebruik met hydraulische hulptrekkers
 Separadores para uso con dispositivos extractores hidráulicos
 Separatori per i dispositivi di estrazione idraulici
 Urządzenia rozdzielające do ściągaczy hydraulicznych



Art.-No.		mm	mm	max. t		EUR
Y-215-2	-172106	22 - 115	115	15	1	160,30
Y-215-3	-039546	25 - 155	152	15	1	262,10
Y-215-4	-385629	30 - 200	200	15	1	629,20
Y-315-4	-398186	30 - 200	200	20	1	631,10
Y-315-5	-041501	30 - 250	250	20	1	1089,20
Y-515-5	-400063	30 - 250	250	30	1	1142,10
Y-515-6	-043581	75 - 330	330	30	1	2387,10
Y-515-7	-172281	80 - 420	420	30	1	4940,60

Innenauszieher
HY

Y221-E



Internal extractor
 Extracteur intérieur
 Binnentrekkers
 Extractor interior
 Estrattore interno
 Ściągacze wewnętrzne

Art.-No.		mm	mm	max. t		EUR
Y-221-E	-040856	30 - 180	140	15	1	363,50
Y-321-E	-042836	75 - 230	150	20	1	655,00
Y-521-E	-044656	75 - 230	150	25	1	712,40

Schnellkupplung
HY

YC



High-flow coupling
 Raccord
 Snelkoppeling
 Acoplamiento
 Raccordo a chiusura rapida
 Sprzęgło szybkodziałające

Art.-No.		für for		EUR
YCH-604	-440731	Schlauch / hose	1	85,40
YCR-400	-201318	Zylinder / ram	1	128,50

Hydraulische Handpumpe, Manometer und Schlauch
HY

Y-ERS

Hydraulic hand pump, gauge and hoses
 Pompe à main hydraulique, tuyau flexible et manomètre
 Hydraulische handpomp, manometer en slang
 Bomba manuale, tubo flexible y manómetro
 Pompa idraulica manuale, manometro e tubo flessibile
 Hydrauliczna pompa ręczna, manometr i wąż



Art.-No.		bar	cm ³	mm	max. t				EUR
YHP-320	-045721	700	900	23	50	YF-200, YM-235	-	1	523,80
YHP-321	-111198	700	900	23	50	YHP-320, YF-200	-	1	768,10
YHP-324	-045806	700	900	23	50	YHP-320, YM-235	-	1	842,20
YHP-325	-045981	700	900	23	50	YHP-320, YF-200, YM-235	-	1	1085,60
YHP-326	-046483	700	900	23	50	YHP-325	Metall	1	1256,50
YF-200	-045646	2 m Schlauch				YHP-320	-	1	244,20
YM-235	-157769	700 bar Manometer				YF-200, YHP-320	-	1	318,80
YGA-2	-458644	Adapter					-	1	99,30

Hub-Zylinder
HY

YSM



Lift cylinder
 Vérin de relevage
 Hefcylinder
 Cilindro elevador hidráulico
 Cilindro sollevatore
 Cylinder pompy tłokowej

Art.-No.		mm	max. t		EUR
YSM-100	-101007	12	10	1	867,40
YSM-200	-102004	11	20	1	1155,80

Mobiler Hydraulik-Abzieher „GOLIATH“

HY

GOLIATH

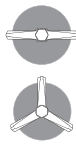

Mobile hydraulic puller „GOLIATH“
 Extracteur hydraulique mobil „GOLIATH“
 Mobile hydraulische trekker „GOLIATH“
 Extractor hidráulico móvil „GOLIATH“
 Estrattore idraulico mobile „GOLIATH“
 Mobilny ściągacz hydrauliczny „GOLIATH“



Art.-No.				max. t			EUR
		mm	mm		Volt		
GOLIATH	-978326	1200	700	60	230	1	17857,50

Mobile Hydraulik-Trennvorrichtung „GOLIATH 2“

HY

GOLIATH2

Mobile hydraulic separator „GOLIATH 2“
 Décolleur hydraulique mobile „GOLIATH 2“
 Mobile hydraulische scheidende trekker „GOLIATH 2“
 Separador hidráulico móvil „GOLIATH 2“
 Separatore idraulico mobile „GOLIATH 2“
 Mobilne hydrauliczne narzędzie rozdzielające „GOLIATH 2“



Art.-No.					max. t			EUR
		mm	mm	mm		Volt		
GOLIATH-2	-995057	75 - 330	180-400	600	30	230	1	19135,30

Lager-Anwärmegeräte

HY

T-AW

Inductive heater
 Appareil de réchauffage
 Inductie heater
 Calentador inductivo
 Dispositivi di riscaldamento cuscinetti
 Podgrzewacze







Art.-No.					EUR
		mm	kg		
T-AW-20	-830976	120	40	1	3703,80
T-AW-40	-831133	180	70	1	5291,20

Schlag-Maulschlüssel (DIN 133)
ST

133



Open-end slogging spanners (DIN 133)
 Clés à fourche à frapper (DIN 133)
 Steekslagsleutels (DIN 133)
 Llaves fijas de golpe (DIN 133)
 Chiavi a forchetta a percussione (DIN 133)
 Udarowy klucz szczękowy (DIN 133)



Art.-No.	 4021176	 mm	 mm		EUR
133-24	-865213	24	170	1	19,00
133-27	-854804	27	175	1	21,10
133-30	-854989	30	195	1	22,40
133-32	-855061	32	195	1	23,10
133-34	-904394	34	195	1	31,00
133-36	-855146	36	195	1	31,00
133-41	-855221	41	245	1	35,50
133-46	-855306	46	245	1	43,30
133-50	-855481	50	270	1	50,00
133-55	-855559	55	310	1	62,10
133-60	-855634	60	310	1	67,10
133-65	-855719	65	340	1	84,10
133-70	-855894	70	375	1	106,40
133-75	-855979	75	380	1	117,10
133-80	-856051	80	405	1	142,50
133-85	-856136	85	410	1	153,70
133-90	-856211	90	450	1	211,70
133-95	-856396	95	450	1	220,70
133-100	-856471	100	485	1	421,10
133-105	-865176	105	500	1	496,50
133-110	-865183	110	500	1	508,80
133-115	-865190	115	525	1	679,70
133-120	-865206	120	525	1	706,90

Zug-Ringschlüssel
ST

402



Heavy duty ring spanners
 Clés polygonales à manche adaptable
 Opsteekringsleutels
 Llaves de golpe, estrella luneta
 Chiavi poligonali di trazione
 Klucz oczkowy odgięty

Art.-No.	 4021176	 mm		EUR
402-24	-963858	24	1	29,30
402-27	-963865	27	1	30,40
402-30	-963872	30	1	32,50
402-32	-963889	32	1	34,50
402-36	-963896	36	1	44,10
402-41	-963902	41	1	51,20
402-46	-963919	46	1	60,10
402-50	-963933	50	1	70,10
402-55	-963940	55	1	75,90
402-60	-963957	60	1	100,60
402-65	-963971	65	1	108,30
402-70	-963988	70	1	130,70
402-75	-963995	75	1	140,60
402-80	-964015	80	1	174,20



Aufsteckrohre

ST

402



Spanner extensions
Rallonges
Pijpgrepen
Cabos extensivos
Tubi di collegamento
Rurki nasadzane

Art.-No.		 mm		EUR
402-460	-963926	460	1	23,20
402-610	-963964	610	1	33,70
402-760	-964008	760	1	50,20
402-860	-964022	860	1	67,30





Schlag-Ringschlüssel (DIN 7444)

ST

406



Slogging spanners (DIN 7444)
Clés polygonales à frapper (DIN 7444)
Ringslagsleutels (DIN 7444)
Llaves poligonales de golpe (DIN 7444)
Chiavi poligonali a percussione (DIN 7444)
Udarowy klucz oczkowy (DIN 7444)



Art.-No.		 mm	 mm		EUR
406-24	-856549	24	180	1	17,60
406-27	-856624	27	180	1	21,40
406-30	-856709	30	185	1	25,00
406-32	-856884	32	190	1	27,20
406-34	-904431	34	195	1	34,70
406-36	-856969	36	195	1	34,70
406-38	-865961	38	205	1	36,00
406-41	-857041	41	230	1	43,60
406-46	-857126	46	235	1	46,50
406-50	-857201	50	240	1	54,00
406-55	-857386	55	270	1	60,20
406-60	-857461	60	270	1	64,80
406-65	-857539	65	280	1	84,50
406-70	-857614	70	330	1	93,10
406-75	-857799	75	330	1	100,60
406-80	-857874	80	345	1	142,50
406-85	-857959	85	380	1	173,50
406-90	-858031	90	380	1	209,00
406-95	-858116	95	380	1	236,00
406-100	-858291	100	430	1	264,80
406-105	-858376	105	430	1	372,80
406-110	-858451	110	430	1	401,80
406-115	-858529	115	430	1	440,10
406-120	-858604	120	482	1	962,70

Doppel-Ringschlüssel, tief gekröpft (DIN 838)
ST

1002



Double-ended ring spanners, deep offset (DIN 838)
 Clés polygonales contre-coudées (DIN 838)
 Dubbele ringsleutels, diep doorgezet (DIN 838)
 Llaves lunetas (DIN 838)
 Chiavi poligonali doppie, piegate a gomito profonda (DIN 838)
 Podwójny klucz oczkowy, mocno zagięty (DIN 838)



Art.-No.		 mm		EUR
1002-06x07	-963605	6 x 7	10	3,70
1002-08x09	-964398	8 x 9	10	4,00
1002-10x11	-964404	10 x 11	10	4,10
1002-12x13	-964411	12 x 13	10	4,90
1002-12x14	-964428	12 x 14	10	7,30
1002-13x15	-964435	13 x 15	10	7,50
1002-14x15	-964442	14 x 15	10	6,70
1002-16x17	-964459	16 x 17	10	7,70
1002-17x19	-964466	17 x 19	10	9,10
1002-18x19	-964473	18 x 19	10	9,10
1002-19x22	-964480	19 x 22	10	9,60
1002-20x22	-964497	20 x 22	10	9,80
1002-21x23	-964503	21 x 23	10	11,90
1002-22x24	-968334	22 x 24	10	12,00
1002-24x26	-968341	24 x 26	5	15,20
1002-24x27	-968358	24 x 27	5	15,20
1002-24x30	-266058	24 x 30	5	19,00
1002-25x28	-968365	25 x 28	5	19,00
1002-27x30	-968372	27 x 30	5	22,60
1002-27x32	-968389	27 x 32	5	20,30
1002-30x32	-968396	32 x 32	5	21,30
1002-30x34	-968402	30 x 34	5	26,80

Doppel-Ringschlüssel, tief gekröpft (DIN 838) im Satz
ST

1002



Set of ring spanners, deep offset (DIN 838)
 Jeu de clés polygonales contre-coudées (DIN 838)
 Dubbele ringleutel-sets, diep doorgezet (DIN 838)
 Juego de llaves lunetas (DIN 838)
 Set di chiavi poligonali doppie, piegate a gomito profonda (DIN 838)
 Podwójny klucz oczkowy, mocno zagięty (DIN 838) w zestawie

Art.-No.		 mm	Stück pieces		EUR
1002-S-08	-968426	6 - 22	8	1	50,20
1002-S-10	-696985	6 - 32	10	1	86,60
1002-S-12	-968440	6 - 32	12	1	117,30
1002-S-13	-968457	6 - 41	13	1	160,20
1002-SA-10	-983214	6 - 26	10	1	77,00
1002-SA-12	-983221	6 - 32	12	1	117,30



Doppel-Ringschlüssel, gerade (DIN 837 B)

ST

1004



Double ended ring spanners, straight (DIN 837 B)
 Clés polygonales, droites (DIN 837 B)
 Dubbele ringsleutels, plat (DIN 837 B)
 Llaves estrella planas (DIN 837 B)
 Chiavi poligonali doppie, dritte (DIN 837 B)
 Podwójny klucz oczkowy, prosty (DIN 837 B)

Art.-No.		 mm		EUR
1004-06x07	-968556	6 x 7	10	3,70
1004-08x09	-968563	8 x 9	10	3,80
1004-10x11	-968570	10 x 11	10	4,00
1004-12x13	-968587	12 x 13	10	4,20
1004-14x15	-968594	14 x 15	10	5,50
1004-16x17	-968600	16 x 17	10	6,20
1004-18x19	-968617	18 x 19	10	6,20
1004-20x22	-968624	20 x 22	10	8,20



Doppel-Ringschlüssel, gerade (DIN 837 B) im Satz

ST

1004



Double-ended ring spanner, straight (DIN 837 B), in set
 Jeu de clés polygonales droites (DIN 837 B)
 Dubbele ringsleutels, plat (DIN 837 B) in set
 Juego de llaves de lunetas de dos bocas, planas (DIN 837 B)
 Set di chiavi poligonali doppie, dritte (DIN 837 B)
 Podwójny klucz oczkowy, prosty (DIN 837 B) w zestawie



Art.-No.		 mm	Stück pieces		EUR
1004-S-08	-968631	6-22	8	1	41,60

Doppel-Maulschlüssel (DIN 3110)
ST

1006



Double ended open jaw spanners (DIN 3110)
 Clés à fourche double (DIN 3110)
 Dubbele steeksleutels (DIN 3110)
 Llaves fijas dos bocas (DIN 3110)
 Chiavi a doppia forchetta (DIN 3110)
 Podwójny klucz szczękowy (DIN 3110)



Art.-No.		 mm		EUR
1006-06x07	-968648	6 x 7	10	2,50
1006-07x08	-968655	7 x 8	10	2,90
1006-08x09	-968662	8 x 9	10	2,60
1006-10x11	-968686	10 x 11	10	2,90
1006-10x12	-968693	10 x 12	10	3,30
1006-10x13	-968709	10 x 13	10	3,70
1006-12x13	-968716	12 x 13	10	3,40
1006-12x14	-968723	12 x 14	10	4,00
1006-13x14	-968730	13 x 14	10	4,10
1006-13x17	-968747	13 x 17	10	5,80
1006-14x15	-968754	14 x 15	10	4,20
1006-14x17	-968761	14 x 17	10	5,80
1006-16x17	-968778	16 x 17	10	5,30
1006-17x19	-968785	17 x 19	10	6,60
1006-18x19	-968792	18 x 19	10	6,10
1006-19x22	-968808	19 x 22	10	7,50
1006-20x22	-968815	20 x 22	10	6,60
1006-21x23	-968822	21 x 23	10	6,90
1006-21x24	-968839	21 x 24	10	7,70
1006-22x24	-968846	22 x 24	10	7,80
1006-24x26	-968853	24 x 26	10	7,90
1006-24x27	-968860	24 x 27	10	7,90
1006-24x30	-266126	24 x 30	10	11,60
1006-25x28	-968877	25 x 28	10	11,20
1006-27x29	-968884	27 x 29	10	12,70
1006-27x30	-968891	27 x 30	10	12,70
1006-27x32	-968907	27 x 32	10	12,70
1006-30x32	-968914	30 x 32	10	12,70
1006-30x34	-968921	30 x 34	5	15,70
1006-30x36	-968938	30 x 36	5	17,20
1006-32x36	-968945	32 x 36	5	21,70
1006-36x41	-968952	36 x 41	5	28,40

Doppel-Maulschlüssel (DIN 3110) im Satz
ST

1006



Set of double ended open jaw spanners
 Jeu de clés à fourche double (DIN 3110)
 Dubbele steeksleutel-sets (DIN 3110)
 Juego de llaves fijas dos bocas (DIN 3110)
 Set di chiavi a doppia forchetta (DIN 3110)
 Podwójny klucz szczękowy (DIN 3110) w zestawie

Art.-No.		 mm	Stück pieces		EUR
1006-S-08	-968969	6 - 22	8	1	33,10
1006-S-10	-696992	6 - 32	10	1	53,60
1006-S-12	-968983	6 - 32	12	1	71,60
1006-S-13	-968990	6 - 41	13	1	100,10
1006-SA-10	-983238	6 - 26	10	1	47,80
1006-SA-12	-983245	6 - 32	12	1	71,60
1006-SA-13	-983252	6 - 32	13	1	84,20

Ring-Maulschlüssel DIN 3113, Form A, ISO 7738

ST

1007



Combination spanners DIN 3113, Form A, ISO 7738



Clés mixtes DIN 3113, Form A, ISO 7738

Steekringsleutels DIN 3113, Form A, ISO 7738

Llaves combinadas DIN 3113, Form A, ISO 7738

Chiavi combinate a forchetta e poligonali DIN 3113, Modello A, ISO 7738

Klucz szczękowy oczkowy DIN 3113, forma A, ISO 7738

Art.-No.		 mm		EUR
1007-05	-969072	5,5	10	2,50
1007-06	-969089	6	10	2,50
1007-07	-969096	7	10	2,80
1007-08	-969102	8	10	2,80
1007-09	-969119	9	10	2,80
1007-10	-969126	10	10	2,90
1007-11	-969133	11	10	3,00
1007-12	-969140	12	10	3,60
1007-13	-969157	13	10	3,70
1007-14	-969164	14	10	4,10
1007-15	-969171	15	10	4,10
1007-16	-969188	16	10	4,60
1007-17	-969195	17	10	4,90
1007-18	-969201	18	10	5,80
1007-19	-969218	19	10	6,60
1007-20	-969225	20	10	6,70
1007-21	-969232	21	10	7,10
1007-22	-969249	22	10	7,40
1007-23	-969256	23	5	9,80
1007-24	-969263	24	5	10,20
1007-25	-969270	25	5	11,90
1007-26	-969287	26	5	12,00
1007-27	-969294	27	5	13,30
1007-28	-969300	28	5	13,90
1007-29	-969317	29	5	15,20
1007-30	-969324	30	5	16,10
1007-32	-969331	32	5	17,70
1007-34	-983269	34	5	23,90
1007-36	-969348	36	5	23,90
1007-38	-983283	38	5	36,40
1007-41	-969355	41	5	31,80
1007-46	-266157	46	1	70,70
1007-50	-266188	50	1	79,10

Ring-Maulschlüssel (DIN 3113) im Satz

ST

1007



Set of combination spanners (DIN 3113)



Jeu de clés mixtes (DIN 3113)

Steekringsleutel-sets (DIN 3113)

Juego de llaves combinadas (DIN 3113)

Set di chiavi combinate a forchetta e poligonali (DIN 3113)

Klucz szczękowy oczkowy (DIN 3113) w zestawie



Art.-No.		 mm	Stück pieces		EUR
1007-S-08	-983306	8 - 22	8	1	35,70
1007-S-09	-969362	6 - 19	9	1	36,40
1007-S-12	-969379	6 - 24	12	1	60,50
1007-S-15	-969386	6 - 32	15	1	108,30
1007-S-17	-975707	6 - 22	17	1	74,90
1007-S-19	-969393	5,5 - 24	19	1	87,70
1007-S-26	-969409	6 - 32	26	1	194,80

Doppel-Maulschlüssel (DIN 895)
ST

1895



Double-ended open jaw spanner (DIN 895)
 Clé mixte double (DIN 895)
 Dubbele steeksleutels (DIN 3110)
 Llave fija de dos bocas (DIN 895)
 Chiavi a doppia forchetta (DIN 895)
 Podwójny klucz szczękowy (DIN 895)



Art.-No.		 mm		EUR
1895-36x41	-965791	36 x 41	1	16,50
1895-41x46	-965807	41 x 46	1	23,00
1895-46x50	-965814	46 x 50	1	29,30
1895-50x55	-965821	50 x 55	1	37,90
1895-55x60	-965838	55 x 60	1	45,60

Doppel-Steckschlüssel (DIN 896-B)
ST

1896



Double ended socket wrenches (DIN 896-B)
 Clés en tube droites (DIN 896-B)
 Dubbele pijpsleutels (DIN 896-B)
 Llaves de tubo (DIN 896-B)
 Chiavi a bussola doppia (DIN 896-B)
 Podwójny klucz nasadowy (DIN 896-B)



Art.-No.		 mm		EUR
1896-06x07	-969560	6 x 7	10	4,20
1896-08x09	-969584	8 x 9	10	4,60
1896-10x11	-969607	10 x 11	10	5,40
1896-12x13	-969621	12 x 13	10	6,30
1896-13x15	-969645	13 x 15	10	6,70
1896-14x15	-969669	14 x 15	10	6,90
1896-16x17	-969683	16 x 17	10	8,60
1896-18x19	-969706	18 x 19	10	9,20
1896-20x22	-969720	20 x 22	10	9,80
1896-21x23	-969744	21 x 23	5	10,30
1896-24x26	-969768	24 x 26	5	15,20
1896-24x27	-969782	24 x 27	5	15,40
1896-25x28	-969805	25 x 28	5	16,80
1896-27x32	-969829	27 x 32	5	16,90

Doppel-Steckschlüssel (DIN 896-B) im Satz
ST

1896



Double ended socket wrenches (DIN 896-B)
 Clés en tube droites (DIN 896-B)
 Dubbele pijpsleutel-sets (DIN 896-B)
 Llaves de tubo (DIN 896-B)
 Set di chiavi a bussola doppia (DIN 896-B)
 Podwójny klucz nasadowy (DIN 896-B) w zestawie



Art.-No.		 mm	Stück pieces		EUR
1896-S-08	-969867	6 - 22	8	1	54,90
1896-S-12	-969874	6 - 32	12	1	114,10

Universal Drehstift
ST

1896



Universal tommy bar
 Broche à réduction universel
 Universele draaistift
 Perno passante universal
 Spina di manovra universale
 Uniwersalny trzpień obrotowy

Art.-No.		∅ mm	L mm		EUR
1896-57	-969843	6; 8; 10; 12	185	10	7,90